



INSTALLATION INSTRUCTIONS

LEDVANCE LED TUBE T8 AND T5 LEDVANCE DULUX LED

PORTFOLIO

PRODUCT SEGMENT

LED TUBE T8 EM

LED TUBE T8 UNIVERSAL

LED TUBE T8 HF

T8



Compatibility

Electromagnetic control gear (CCG) or mains voltage (220–240 V)

Electromagnetic control gear (CCG), compatible electronic control gear (ECG) or mains voltage (220–240 V)

Compatible electronic control gear (ECG)

PRODUCT SEGMENT

LED TUBE T5 HF

LED TUBE T5 AC

T5



Compatibility

Compatible electronic control gear (ECG)

Mains voltage (220–240 V)

PRODUCT SEGMENT

LED TUBE EXTERNAL T8/T5

LED DRIVER LED TUBE EXTERNAL DALI

T8/T5 EXTERNAL SYSTEM



Compatibility

LED DRIVER LED TUBE EXTERNAL DALI

LED TUBE EXTERNAL T8/T5

PRODUCT SEGMENT

DULUX S, G, D, T, F, SQ EM

DULUX D/E, L, T/E HF

DULUX LED



Compatibility

Electromagnetic control gear (CCG) or mains voltage (220–240 V)

Compatible electronic control gear (ECG) or mains voltage (220–240 V)

CONTENTS

1	INSTALLATION OPTIONS	04
1.1	Retrofitting in CCG luminaires	04
1.2	Retrofitting in ECG luminaires	04
1.3	Conversion of existing luminaires to mains voltage	04
1.4	Testing the control gear (CCG or ECG)	05
<hr/>		
2	RETROFITTING	06
2.1	Retrofitting a T8 fluorescent lamp in a CCG lamp	06
2.1.1	Luminaires with PF correction capacitor	07
2.1.2	Tandem operation	08
2.2	Retrofitting a T5/T8 fluorescent lamp in an ECG luminaire	09
2.3	ECG compatibility check	11
2.4	Retrofitting CFLni lamps with CCG	12
2.4.1	LEDVANCE DULUX LED S EM	13
2.4.2	LEDVANCE DULUX LED D EM, D VERTICAL EM & T EM	14
2.4.3	LEDVANCE DULUX LED F EM	14
2.4.4	LEDVANCE DULUX LED SQ EM (SQUARE)	15
2.5	Retrofitting CFLni lamps on compatible ECGs	16
2.5.1	LEDVANCE DULUX LED D/E HF & T/E HF	16
2.5.2	LEDVANCE DULUX LED L HF	17
<hr/>		
3	CONVERSION	18
3.1	Operating T8 and T5 tubes on mains voltage	18
3.1.1	Installation instructions for T8 and T5 tubes	19
3.1.2	Sample installation for converting T8 and T5 tubes	20
3.2	LED TUBE EXTERNAL SYSTEM	21
3.3	Operating DULUX LED on mains voltage	26
<hr/>		
4	NOTES ON OPERATING TEMPERATURE	30

1 INSTALLATION OPTIONS

1.1 RETROFITTING IN CCG LUMINAIRES

Retrofitting involves replacing the T8 fluorescent lamp and the built-in starter with LED TUBE T8 EM and LED TUBE Starter. Alternatively, LED TUBE T8 UNIVERSAL and corresponding LED TUBE UN Starter can be used for CCG luminaires.

1.2 RETROFITTING IN ECG LUMINAIRES

Retrofitting involves replacing the T5/T8 fluorescent lamp with LED TUBE T5/T8 HF or LED TUBE T8 UNIVERSAL. Before installation, check www.ledvance.com/ecg-compatibility or the web app at www.ledvance.com/tubefinder whether the selected LED TUBE is compatible with the ECG installed in the luminaire.

1.3 CONVERSION OF EXISTING LUMINAIRES TO MAINS VOLTAGE

Conversion brings additional potential energy-savings by eliminating the energy losses at the existing control gear and reduces maintenance costs by removing components that require maintenance.

Conversion is also a cost-effective alternative if the electronic control gear (ECG) installed in the luminaire is not compatible with LED TUBE UNIVERSAL/HF.

All LED TUBE T8 EM, LED TUBE T8 UNIVERSAL and LED TUBE T5 AC products are suitable for connecting directly to mains voltage. Section 3.2 lists the steps and requirements for conversion.

The LEDVANCE LED TUBE EXTERNAL SYSTEM, consisting of T5 and T8 constant-current LED tubes and matching DALI-2 LED drivers, however, enables existing DALI-controlled fluorescent lamp installations to be converted. All the details on these products can be found at www.ledvance.com/ext-system.

OVERVIEW OF INSTALLATION OPTIONS

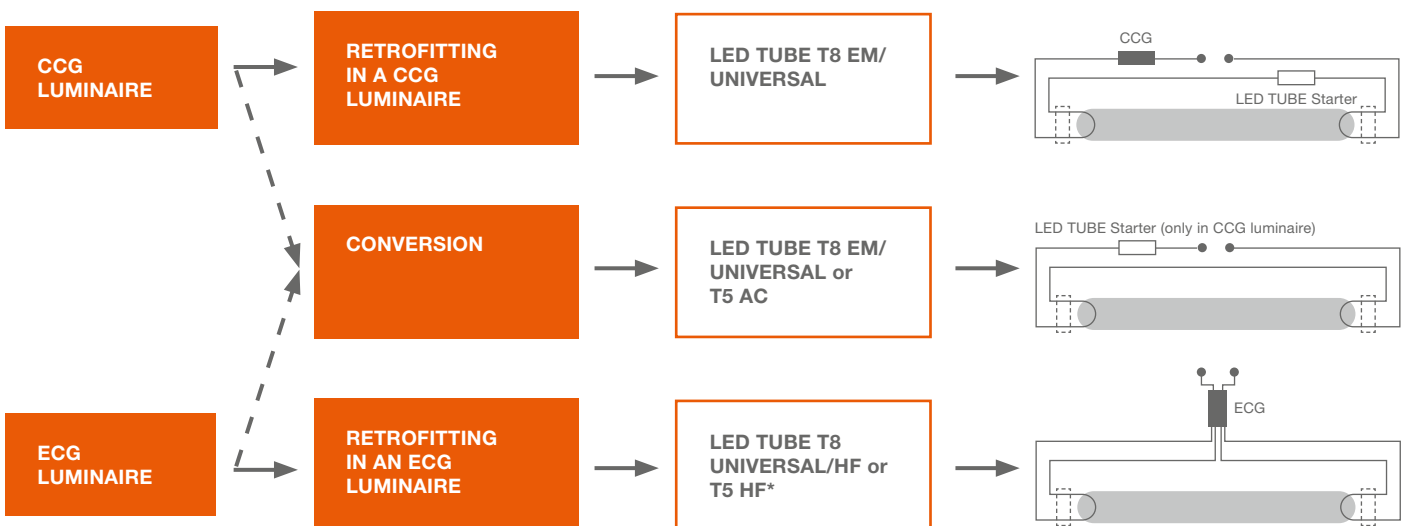

* Check ECG compatibility at ledvance.com/ecg-compatibility or ledvance.com/tubefinder

1.4 TESTING THE CONTROL GEAR (CCG OR ECG)

If you don't know which LED Tube technology (CCG (EM) or ECG (HF) lamp) you need for your T8 lamp our insider tip gives you two ways in which you can easily find out.

INSIDER TIP

STARTER TEST:



CCG luminaire
LED TUBE EM/
UNIVERSAL

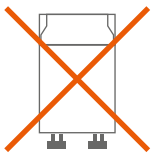

ECG luminaire
LED TUBE HF
(High
Frequency)

CAMERA TEST:

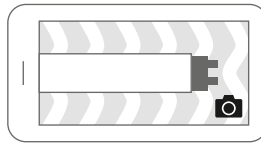

CCG luminaire
LED TUBE EM/
UNIVERSAL

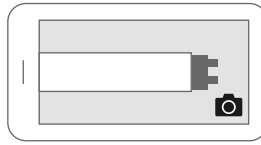

ECG luminaire
LED TUBE HF
(High
Frequency)

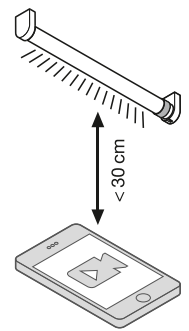

STARTER TEST

Check whether the luminaire you want to fit the new lamp in has a starter. If it does, you need an LED TUBE T8 EM or UNIVERSAL for operating on a CCG. If not, use an ECG-compatible HF or UNIVERSAL LED tube. Before upgrading, check for compatibility at www.ledvance.com/ecg-compatibility or the web app at www.ledvance.com/tubefinder

CAMERA TEST

If the luminaire still has a working T8 lamp, take a look at it through a digital camera (such as the one on your smartphone or tablet).

If the light flickers you need an LED TUBE T8 EM or UNIVERSAL for operating on a CCG. Otherwise use an ECG-compatible HF or UNIVERSAL LED tube. Before upgrading, check for compatibility at www.ledvance.com/ecg-compatibility or the web app at www.ledvance.com/tubefinder

* For the test we recommend a maximum distance of 30 cm between the digital camera and the luminaire.

2 RETROFITTING

LED tubes that are intended as simple one-for-one replacements of conventional fluorescent lamps are called retrofit lamps. The lamp and the LED TUBE Starter are simply fitted in the existing luminaire. Installing the LED TUBE Starter and the LED tube does not involve any structural modifications to the existing luminaire so the CE label for the luminaire remains valid.

2.1 RETROFITTING A T8 FLUORESCENT LAMP IN A CCG LUMINAIRE

Simple retrofitting of the luminaire with an LED tube: The T8 fluorescent lamp is replaced by an LED TUBE T8 EM or UNIVERSAL and the starter is replaced by an LED TUBE Starter. The losses at the CCG are usually reduced to as low as 1 W.



NOTE:

If the starter is not replaced by an LED TUBE Starter, the lamp will begin to flash. In this case, immediately switch off the luminaire and replace the starter, otherwise the LED TUBE T8 EM/ UNIVERSAL may be damaged. LED TUBE T8 EM can only be used in luminaires which have a replaceable starter.

INSTALLATION STEPS

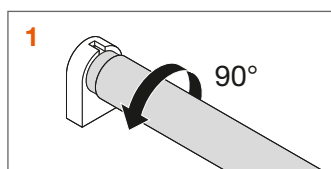

Turn the conventional T8 lamp

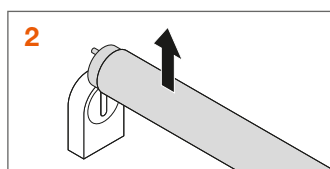

Remove the T8 lamp

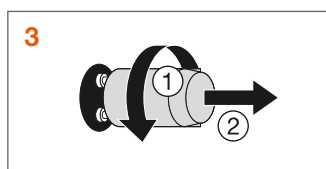

Remove the conventional starter

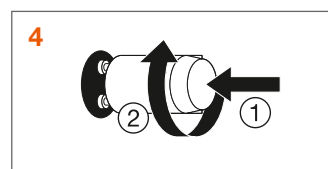

Insert the LED TUBE Starter

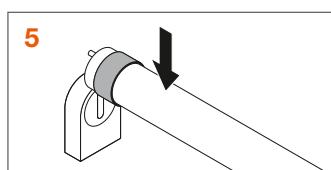

Insert the LED TUBE T8 EM/
UNIVERSAL

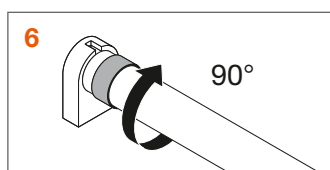

Turn the LED TUBE T8 EM/
UNIVERSAL

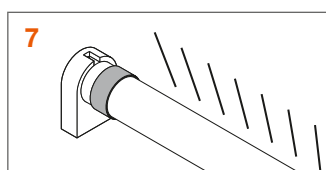

Turn on power



NOTE:

The LED starter supplied with the LED TUBE is necessary for operation.

CIRCUIT DIAGRAM CCG LUMINAIRE WITH RETROFIT LED TUBE

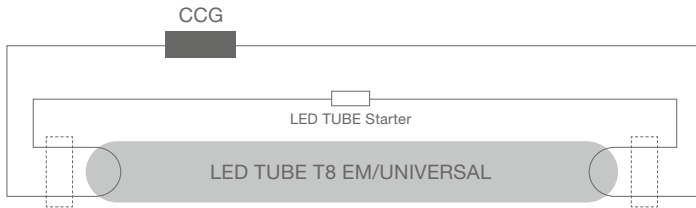

CIRCUIT DIAGRAM OF A DOUBLE-LAMP CCG LUMINAIRE WITH LED TUBES

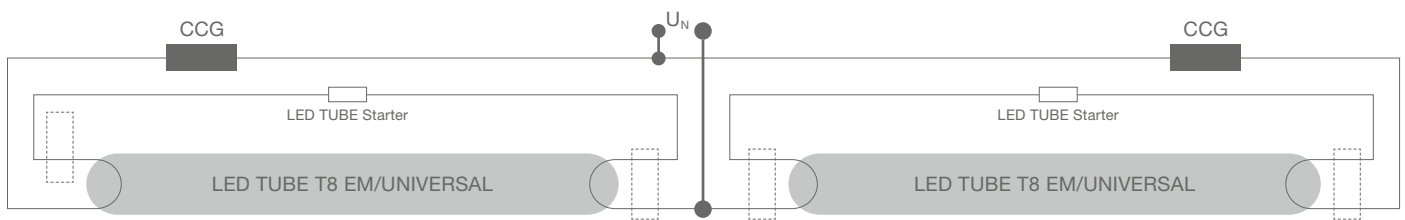

2.1.1 LUMINAIRES WITH PF CORRECTION CAPACITOR

LED TUBE T8 EM or UNIVERSAL can be used in luminaires with built-in compensation capacitors. The maximum number of LED TUBE T8 EM/UNIVERSAL tubes in compensated luminaires on an automatic circuit breaker for this purpose is given in the relevant product data sheet at www.ledvance.com/led-tubes. Since the compensation capacitor reduces the number of LED tubes that can be operated on an automatic circuit breaker, we recommend removing the capacitor.

2.1.2 TANDEM OPERATION

LED TUBE T8 EM tubes with a length of 900 mm or less are suitable for tandem operation.

CIRCUIT DIAGRAM OF A LUMINAIRE IN TANDEM MODE

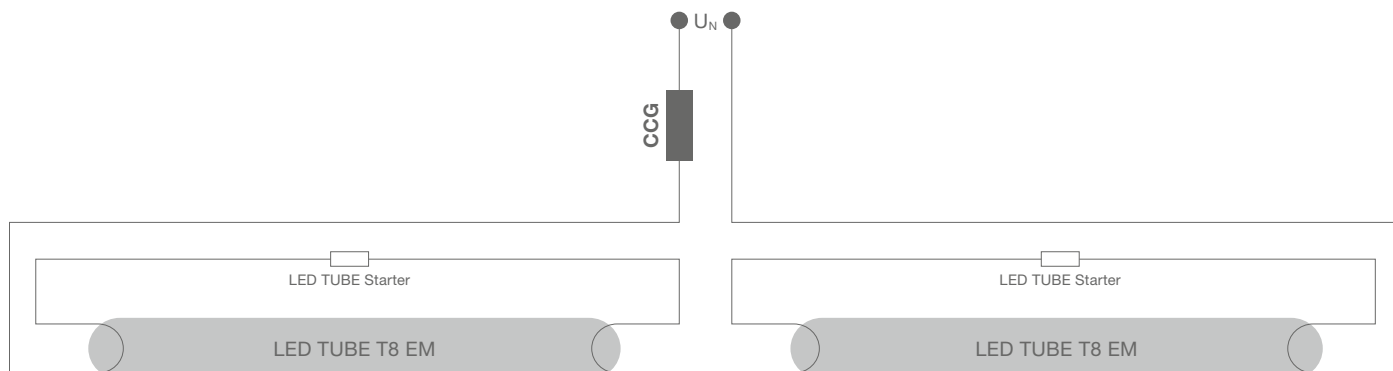
**NOTE:**

LED TUBE T8 EM MOTION SENSOR and LED TUBE T8 UNIVERSAL are not approved for tandem operation.

2 RETROFITTING

2.2 RETROFITTING A T5/T8 FLUORESCENT LAMP IN AN ECG LUMINAIRE

If the luminaire is operated with an ECG you must check that the built-in ECG is compatible with the LED TUBE. LED TUBE T8 HF/UNIVERSAL and T5 HF are compatible with ECGs from different manufacturers.

For more information on the tested ECGs, see the compatibility list at www.ledvance.com/ecg-compatibility or the web app at www.ledvance.com/tubefinder.

CIRCUIT DIAGRAM OF A RETROFITTED ECG LUMINAIRE

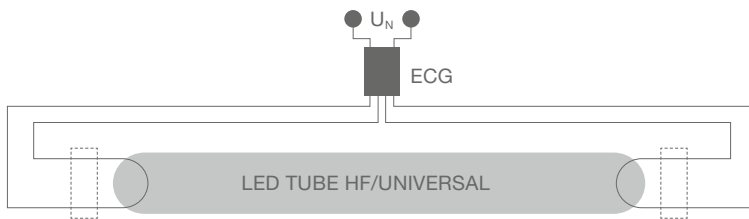

INSTALLATION STEPS

<p>1</p>	<p>2</p>	<p>3</p>	<p>4</p>
Disconnect luminaire from mains	Unscrew and remove the conventional lamp	Insert LED TUBE HF/UNIVERSAL
<p>5</p>	<p>6</p>	<p>7</p>	
Screw in LED TUBE HF/UNIVERSAL	Switch on power	That's it!	

Please check the compatibility of the control gear before installation.



Link to the current compatibility list
www.ledvance.com/ecg-compatibility



Link to the Tubefinder web app
www.ledvance.com/tubefinder

MULTI-CIRCUIT LAMP LUMINAIRES

Double-lamp luminaires can be retrofitted in the same way as single-lamp luminaires. The example below shows the wiring of luminaires with an ECG. If the luminaire is operated with an ECG you must check that the built-in ECG is compatible with LED TUBE HF/UNIVERSAL.

CIRCUIT DIAGRAM OF A RETROFITTED DOUBLE-LAMP LUMINAIRE

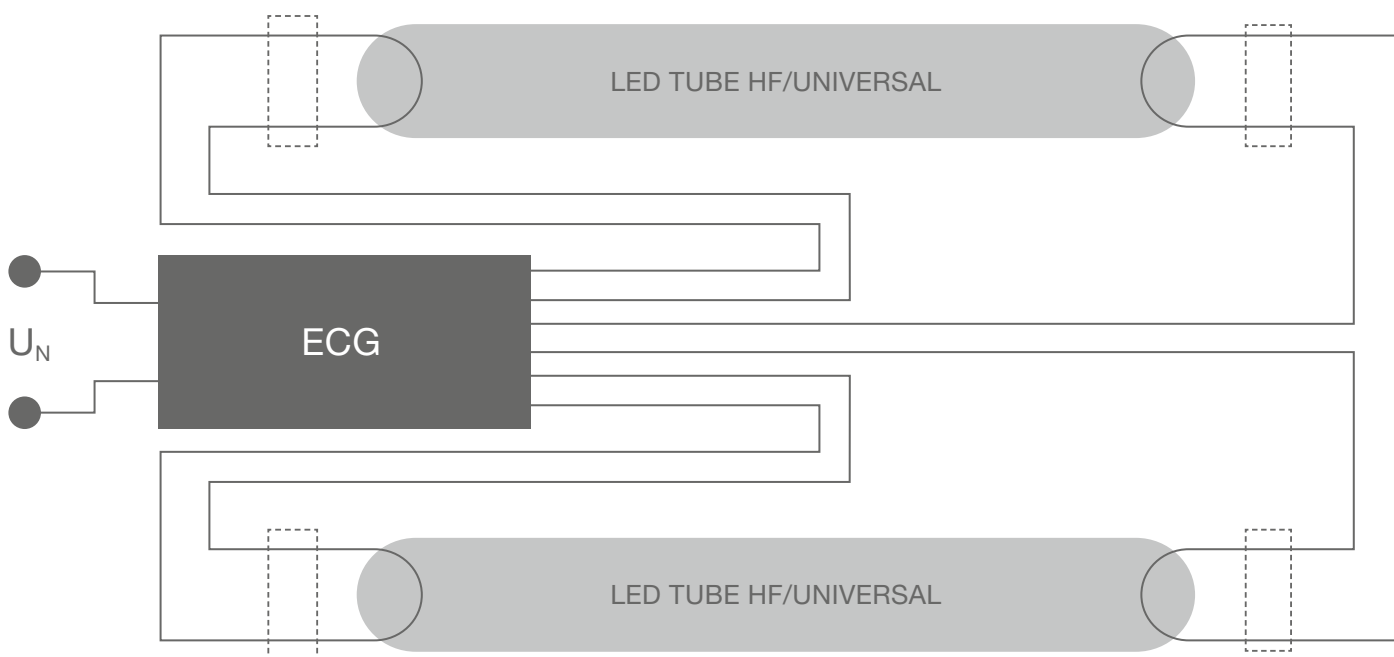

The wiring of the luminaire remains unchanged after retrofitting with LED TUBE HF/UNIVERSAL.

Installing the LED TUBE does not involve any structural modifications to the existing luminaire so the CE label for the luminaire remains valid.

LEDVANCE assumes no responsibility, warranty or liability for the use of

- untested ECGs (see compatibility list)
- non-compatible ECGs (see compatibility list)
- ECGs with the same name but with a different reference number (e.g. successor types) from the tested reference number in the compatibility list.

Please check the compatibility of the control gear before installation.



Link to the current compatibility list
www.ledvance.com/ecg-compatibility



Link to the Tubefinder web app
www.ledvance.com/tubefinder

2.3 ECG COMPATIBILITY CHECK

Here's how to check for ECG compatibility:

STEP 1

Check the exact type of ECG in the luminaire before installation.

Check the brand and name of the ECG, for example:

OSRAM QT-FIT8 1X36;

SIGNIFY HF-P 254/255

Check the precise reference no. of the ECG. Different ECG reference numbers may result in different compatibilities.

STEP 2

Check whether the ECG is approved in the compatibility list.

			LEDTUBE T8 HF P 600 7,5W	LEDTUBE T8 HF V 600 8W	
			Product EAN10 No.	Product EAN10 No.	
			4099854026058	4099854026256	
			4099854026072	4099854026270	
			4099854026096		
OSRAM	Model	Ref.no	L *		
	QT-FIT5/8 1x10-39	AA7471801DG	1	OK	OK
	QT-FIT8 1x18	A63169200DG	1	OK	OK
	QI-FIT8 1x18	AA/170402OL	1	OK	OK
	QT-DALI 1x18 DIM	AA3862901DG	1	NO	NO
	QTP8 1x18	A47279000DG	1	OK	OK
	QTP-OPTIMAL 1x18-40	AA6095705DG	1	OK	OK
	QTP-OPTIMAL 1x18 40	AA609570755	1	OK	OK
	QT-FIT5/8 2x10-39	AA440140555	2	OK	OK
	QT-FIT5/8 2x18-39	AA4401403DG	2	OK	OK
	QT-FIT8 2x18	A63172700DG	2	OK	OK
	QT-FIT8 2x18	AA7470902OL	2	OK	OK
	QTP8 2x18	A63164500DG	2	OK	OK

OR check compatibility online with the web app at www.ledvance.com/tubefinder





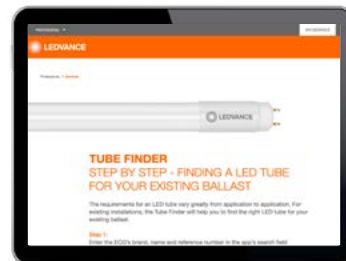





DO YOU NEED ANY HELP?

If you cannot find your ECG in the compatibility list, please contact LEDVANCE GmbH before installation.



2 RETROFITTING

2.4 RETROFITTING OF LEDVANCE DULUX LED LAMPS (CFLNI) WITH CCG

PRODUCT FAMILY CFLni	PRODUCT IMAGE CFLni		PRODUCT IMAGE LED	PRODUCT FAMILY LED
DULUX S G23		▶		DULUX LED S G23
DULUX D G24d		▶		DULUX LED D G24d
		▶		DULUX LED D VERTICAL G24d
DULUX T GX24d		▶		DULUX LED T GX24d
DULUX F 2G10		▶		DULUX F LED 2G10
DULUX SQ GR8		▶		DULUX LED SQ GR8

2.4.1 LEDVANCE DULUX LED S EM

Simple retrofitting of the luminaire with a DULUX LED S: The traditional CFLni with a G23 base is replaced by a DULUX LED S.

1. Check whether it is a G23 base with two pins.
2. Switch off power
3. Remove the existing CFLni lamps from the luminaire
4. Install the LEDVANCE DULUX LED S EM lamp in the luminaire
5. Switch on power

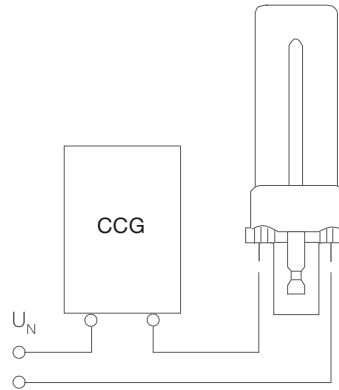

LEDVANCE DULUX LED S EM is not suitable for operating on electronic control gear (ECG).



2.4.2 LEDVANCE DULUX LED D EM G24d, DULUX LED D VERTICAL (VT) EM G24d AND DULUX LED T EM GX24d

Simple retrofitting of the luminaire with a DULUX LED D or T:
The traditional CFLni with a G24d- or Gx24d base is replaced by a DULUX LED D or T.

1. Check whether it is a G24d base with two pins.
2. Switch off power
3. Remove the existing CFLni lamps from the luminaire
4. Install the LEDVANCE DULUX LED lamp in the luminaire
5. LEDVANCE DULUX LED D EM and T EM are intended for horizontal use (position) only
6. LEDVANCE DULUX LED D EM VT (VERTICAL) is intended for vertical use (position) only
7. Switch on power

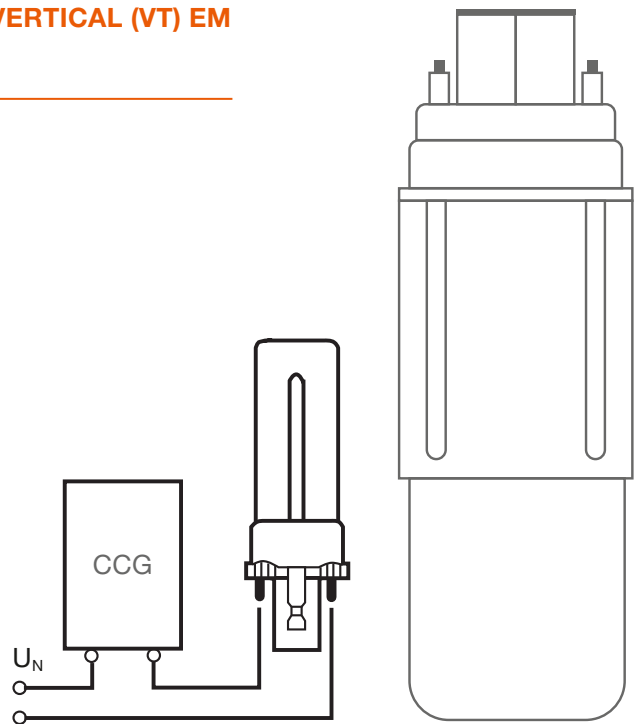

LEDVANCE DULUX LED D and T are not suitable for operating on electronic control gear (ECG).

2.4.3 LEDVANCE DULUX LED F EM

Simple retrofitting of the luminaire with a DULUX LED F: The traditional CFLni with a 2G10 base is replaced by a DULUX LED F.

1. Check whether the control gear installed in the luminaire is a CCG
2. Switch off power
3. Remove the existing CFLni lamps from the luminaire
4. Install the LEDVANCE DULUX LED F EM lamp in the luminaire
5. Switch on power

LEDVANCE DULUX LED F EM is not suitable for operating on electronic control gear (ECG).

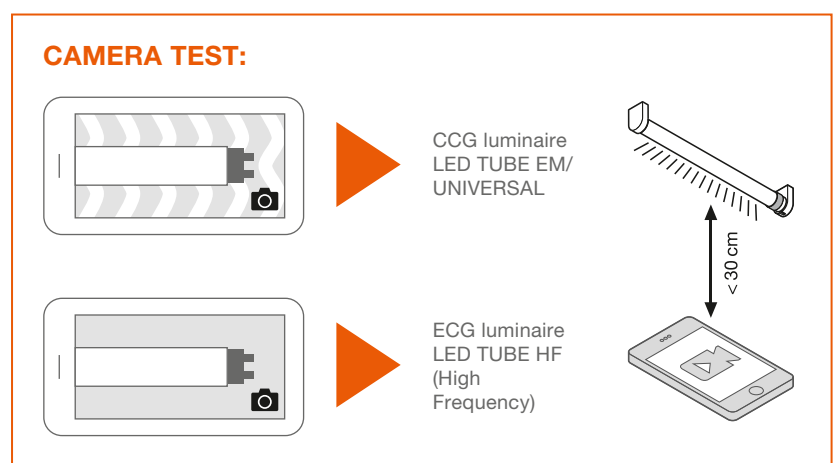

2.4.4 LEDVANCE DULUX LED SQ EM (SQUARE)

Simple retrofitting of the luminaire with a DULUX LED SQ:
The traditional CFLni with a GR8 base is replaced by a DULUX LED SQ.

1. Check that it is a 2-pin GR8 base.
2. Switch off power
3. Remove the existing CFLni lamps from the luminaire
4. Install the LEDVANCE DULUX LED SQ EM (SQUARE) lamp in the luminaire
5. Switch on power

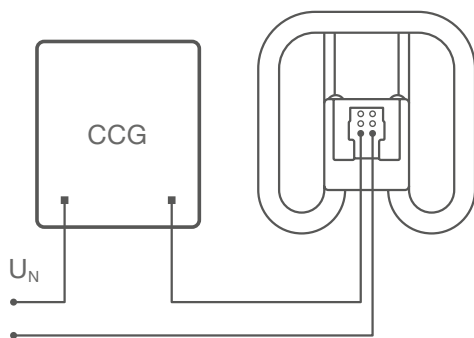







LEDVANCE DULUX LED SQ EM
is not suitable for operating on
electronic control gear (ECG).

2 RETROFITTING

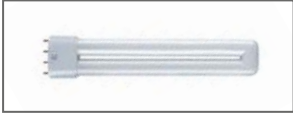
2.5 RETROFITTING OF LEDVANCE DULUX LED LAMPS (CFLni) ON COMPATIBLE ECG

LEDVANCE DULUX LED F, D/E HF and T/E HF are not suitable for operating on electronic control gear (ECG).

PRODUCT FAMILY CFLni	PRODUCT IMAGE CFLni	▶	PRODUCT IMAGE LED	PRODUCT FAMILY LED
DULUX D/E G24q		▶		DULUX LED D/E G24q
DULUX L 2G11		▶		DULUX LED L 2G11
DULUX T/E GX24q		▶		DULUX LED T/E LED GX24q

2.5.1 LEDVANCE DULUX LED D/E HF & T/E HF

1. Check whether it is a G24q or Gx24q base with four pins.
2. Check ECG compatibility at www.ledvance.com/compatibility
3. Switch off power
4. Remove the existing CFLni lamps from the luminaire
5. Install the LEDVANCE DULUX LED HF or the LEDVANCE DULUX LED T/E HF lamp in the luminaire
6. Switch on power

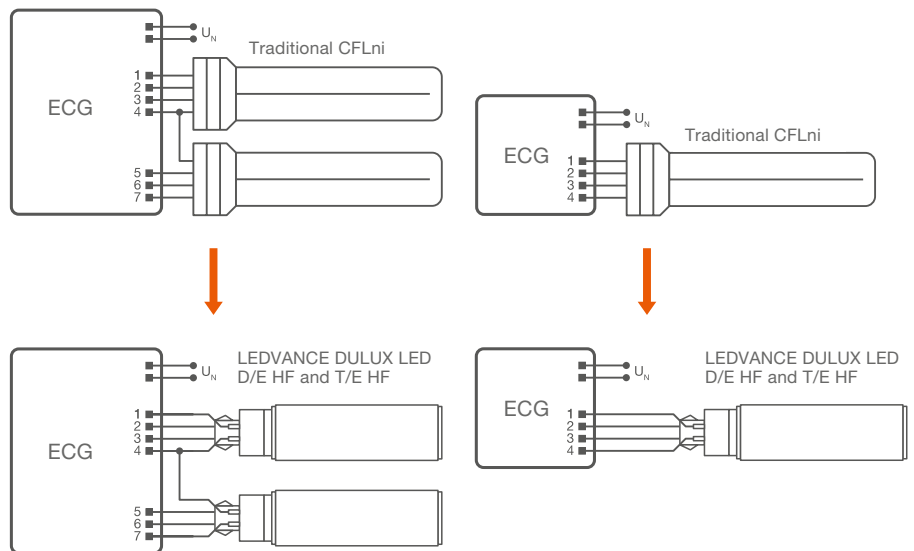

LEDVANCE DULUX LED D/E and T/E HF are not suitable for operating on electromagnetic control gear (CCG).

2.5.2 LEDVANCE DULUX LED L HF

1. Check whether electronic control gear (ECG) is installed in the luminaire (see Camera test, Section 1.4).
2. Check ECG compatibility at www.ledvance.com/compatibility
3. Switch off power
4. Remove the existing DULUX L CFLni lamps from the luminaire
5. Install the LEDVANCE DULUX LED L HF lamp in the luminaire
6. Switch on power

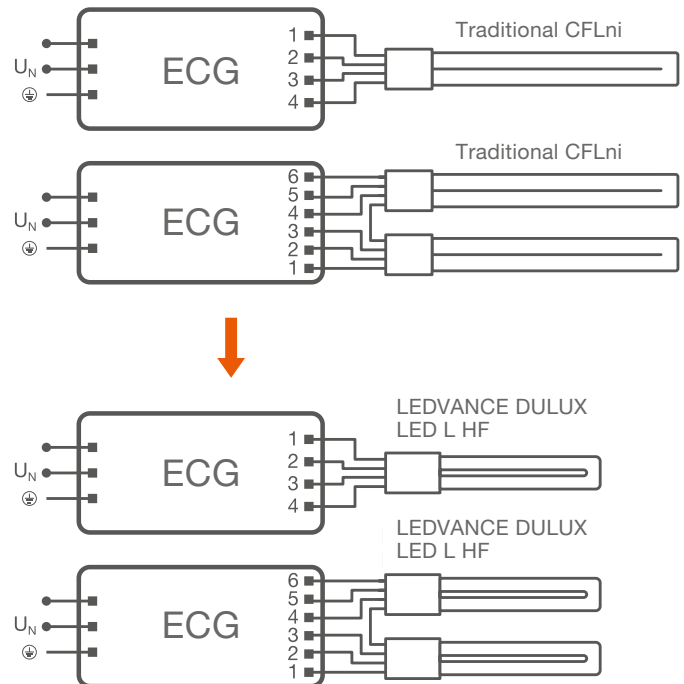

3 CONVERSION

3.1 OPERATION OF T8 AND T5 LED TUBES ON MAINS VOLTAGE

LED TUBE T8 EM or UNIVERSAL and T5 AC can be operated directly on 220V–240V mains voltage. Losses at the CCG or ECG can therefore be avoided.

Conversion also eliminates the need to test the compatibility of the ECG in the case of HF LED tubes. The luminaire must be converted as per 3.3 “Sample installation for conversion” and the diagram below so that LED TUBE T8 EM/UNIVERSAL or T5 AC can be installed in the G13 lamp holder in any orientation.

All the cables must be rated for the relevant voltages and protection classes. The cables within the luminaire must comply with the requirements of the latest versions of EN 50525 and EN 60598-1. Control gear in the luminaire must be removed after conversion.

CIRCUIT DIAGRAM OF A CONVERTED LUMINAIRE ON MAINS VOLTAGE

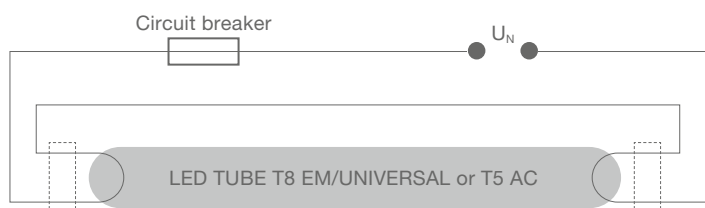

CIRCUIT DIAGRAM OF A CONVERTED DOUBLE-LAMP LUMINAIRE

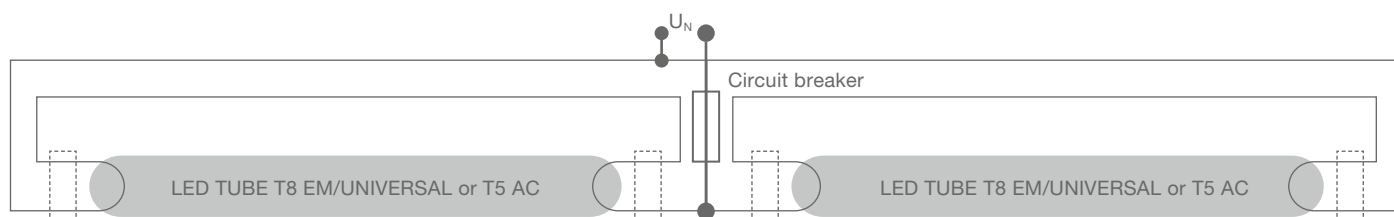

3.1.1 INSTALLATION INSTRUCTIONS FOR T8 AND T5 TUBES

IMPORTANT:

Conversion must be carried out by a qualified electrician.

1. Please follow the five golden rules of electrical safety
2. Remove the conventional fluorescent lamp
3. Remove the control gear and capacitor for reactive power compensation
4. Convert the luminaire as per the circuit diagram on the previous page
5. Insert LED TUBE T8 EM/UNIVERSAL or T5 AC in the lamp holders
6. Ensure that the converted luminaire complies with all the relevant legal requirements, safety regulations and technical standards, such as DIN VDE 0701-0702 and DIN EN 60598-1
7. The converted luminaire must be given a new type plate. The old type plate must be made unrecognizable.



FIVE SAFETY RULES:

1. Disconnect from the mains.
2. Secure against reconnection.
3. Verify that there is no voltage.
4. Carry out earthing and short-circuiting.
5. Cover or block adjacent live parts.

PLEASE NOTE:

After conversion, only LED tubes may be used in the luminaire and not fluorescent lamps. We recommend installing a circuit breaker (250V, T2A) to protect the installation if a fluorescent lamp is installed again by accident. A LEDVANCE LED TUBE can be operated safely and in compliance with relevant standards without this additional circuit breaker. The LEDVANCE LED TUBE conversion kit contains all the materials needed for direct wiring, including a circuit breaker. For product details go to www.ledvance.com/led-tubes.

3.1.2 SAMPLE INSTALLATION FOR CONVERTING T8 AND T5 TUBES

CONVERTING A LUMINAIRE FOR LED TUBE T8 EM WITH CONVERSION KIT (CONTROL GEAR REMOVED)



LED TUBE CONVERSION KIT FOR SINGLE-LAMP LUMINAIRES

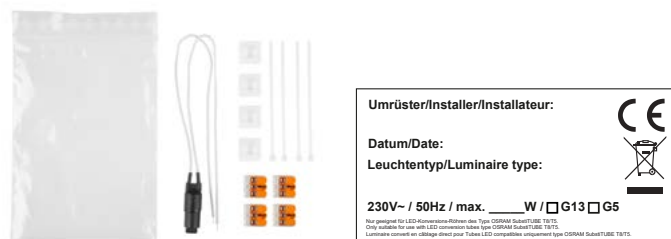

LED TUBE CONVERSION KIT FOR DOUBLE-LAMP LUMINAIRES

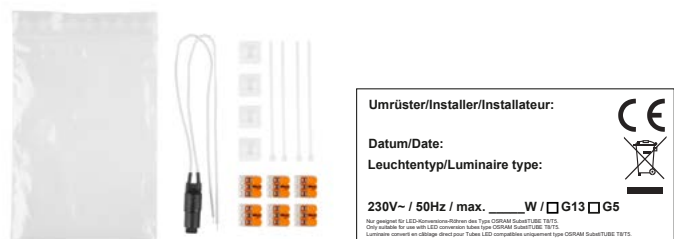

ALTERNATIVE:

Example of a connector box with integrated fuse holder.



3.2 LED TUBE EXTERNAL SYSTEM

The LED TUBE EXTERNAL SYSTEM consists of a T5 or T8 LED tube and perfectly matched external multiwatt DALI-2 driver. The luminaire housing, cabling and – if present – the DALI light management installation can simply be reused.

T8 or T5 fluorescent lamps integrated in a light management system can therefore be converted to efficient LED technology quickly, cost-effectively and without any compatibility problems.

The LED TUBE EXTERNAL SYSTEM is dimmable and suitable for emergency lighting*.

3.2.1 SETTING THE OPERATING CURRENT

LED DRIVER LED TUBE EXTERNAL DALI is a multiwatt driver. The correct operating current for LED TUBE EXTERNAL T5/T8 must be set in advance by means of a DIP switch on LED DRIVER EXTERNAL. LED TUBE EXTERNAL must not be operated outside the specified operating current.

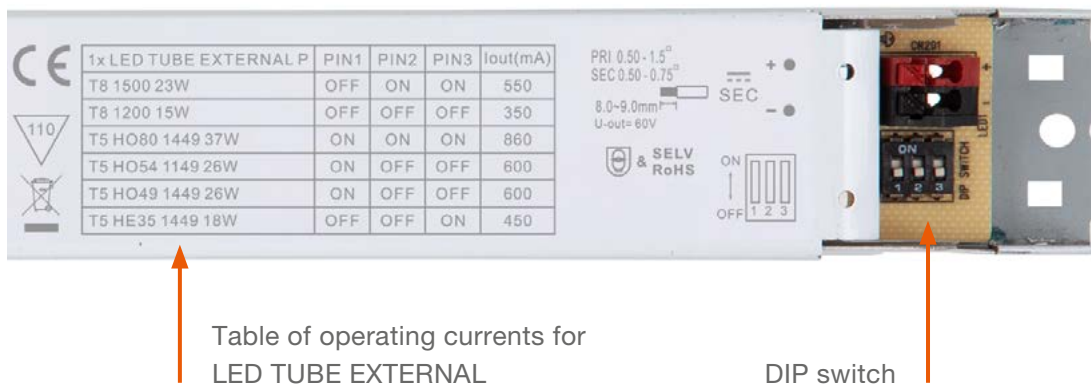

SETTING THE OPERATING CURRENT ON LED DRIVER LED TUBE EXTERNAL DALI-P-1x15-37W 220-240

1 x LED TUBE EXT P	PIN 1	PIN 2	PIN 3	Iout (mA)
T8 1500 23 W	OFF	ON	ON	550
T8 1200 15 W	OFF	OFF	OFF	350
T5 HO80 1449 37 W	ON	ON	ON	860
T5 HO54 1149 26 W	ON	OFF	OFF	600
T5 HO49 1449 26 W	ON	OFF	OFF	600
T5 HE35 1449 18 W	OFF	OFF	ON	450

SETTING THE OPERATING CURRENT ON LED DRIVER LED TUBE EXTERNAL DALI-P-2x15-26W 220-240

2 x LED TUBE EXT P	PIN 1	PIN 2	PIN 3	Iout (mA)
T8 1500 23 W	OFF	ON	ON	550
T8 1200 15 W	OFF	OFF	OFF	350
T5 HO54 1149 26 W	ON	OFF	OFF	600
T5 HO49 1449 26 W	ON	OFF	OFF	600
T5 HE35 1449 18 W	OFF	OFF	ON	450

* Compatibility and the required technical parameters of LED TUBE EXTERNAL T5/T8 must be checked prior to installation according to the applicable emergency lighting standards. Compatibility of LED DRIVER EXTERNAL with the installed central battery system must be checked before installation.

3.2.2 INSTALLATION STEPS

Installation must be carried out by a qualified electrician. All the cables must be rated for the relevant voltages and protection classes. The cables within the luminaire must comply with the requirements of the latest versions of EN 50525 and EN 60598-1. Control gear in the luminaire must be removed after conversion.

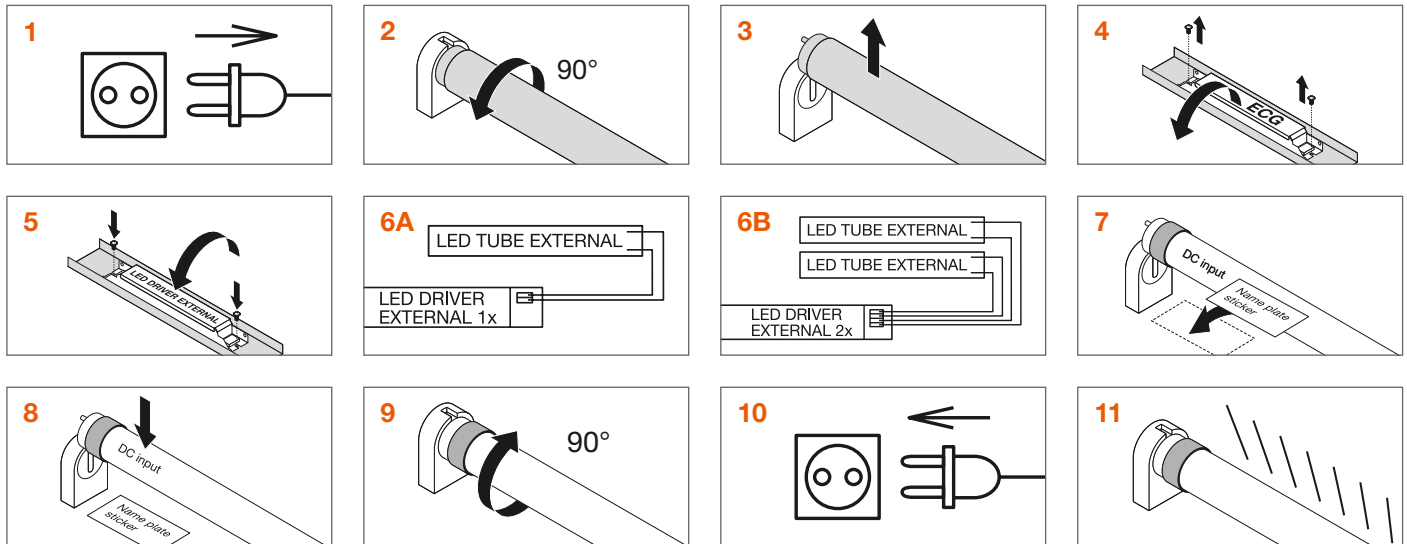

1. Please follow the five golden rules of electrical safety
- 2./3. Remove the conventional fluorescent lamp
4. Remove the control gear
5. Install LED DRIVER EXTERNAL.
Set the operating current for LED TUBE EXTERNAL on the DIP switch
6. Connect the power cable and existing DALI control cable to LED DRIVER EXTERNAL as shown in circuit diagram 6A or 6B.
Connect only one G13/G5 base to the secondary SELV side of LED DRIVER EXTERNAL using existing wires in the luminaire (single-sided LED tube).
Disconnect the cables of the unconnected G13/G5.
7. The converted luminaire must be given a new type plate. Stick the enclosed and completed type plate underneath the connected G13/G5 base. The old type plate must be made unrecognizable.
8. Insert LED TUBE EXTERNAL in the lamp holder
9. Ensure that the converted luminaire complies with all the relevant legal requirements, safety regulations and technical standards, such as DIN VDE 0701-0702 and DIN EN 60598-1

**FIVE SAFETY RULES:**

1. Disconnect from the mains.
2. Secure against reconnection.
3. Verify that there is no voltage.
4. Carry out earthing and short-circuiting.
5. Cover or block adjacent live parts.

LED TUBE EXTERNAL is an LED tube with single-sided feed and may only be connected on the active side (marked “DC Input”). “DC INPUT” is indicated on the LED TUBE EXTERNAL product label. Once you have finished installing, please complete the new type plate, which is included in the LED DRIVER EXTERNAL packaging, and stick it in the luminaire near or below the “DC INPUT” side of the tube. The old type plate must be made unrecognizable.

After the luminaire has been converted only one LED TUBE EXTERNAL may be used. Use of conventional fluorescent tubes or other LED tubes is no longer permitted. LEDVANCE assumes no responsibility, warranty or liability for the use of other types of light source.

Do not use DALI and Push DIM applications at the same time. LED DRIVER EXTERNAL can also be operated as an ON/OFF LED driver without a DALI or Push-DIM connection.

DALI INSTALLATION

- Integration in existing DALI-2 LMS system
- LED DRIVER EXTERNAL can be combined with DALI-2 sensors via a DALI-2 controller

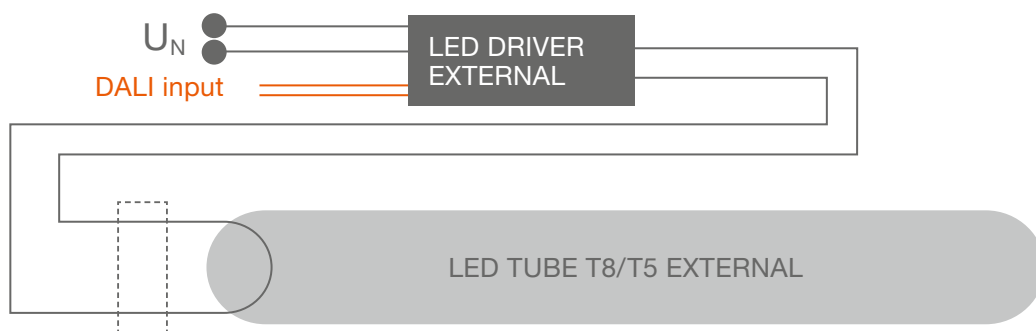

PUSH DIM INSTALLATION

- Dimming via pushbuttons
- Up to 15 LED DRIVER EXTERNAL units can be dimmed with one pushbutton
- Switch the lamp OFF/ON: Press pushbutton
- Dimming: Hold down the pushbutton

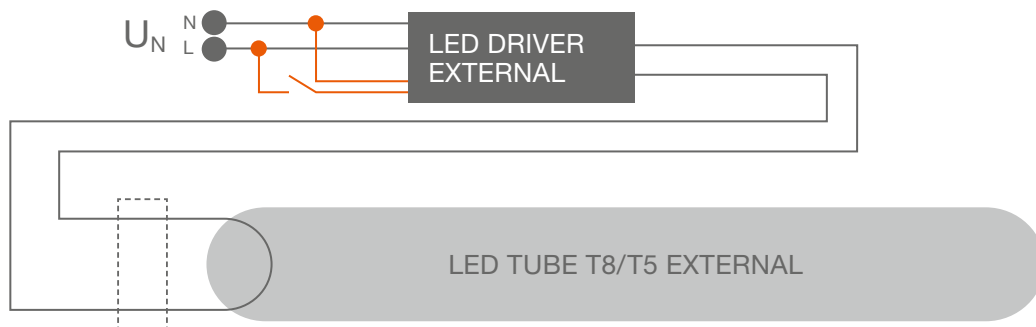

3.2.3 EMERGENCY LIGHTING*

LED TUBE EXTERNAL SYSTEM is suitable for emergency lighting.

OPERATION ON CENTRAL BATTERIES

LED DRIVER EXTERNAL has the EL mark which permits installation in emergency lighting systems in accordance with IEC 61347-2-13, Annex J, for central battery systems. Compatibility of LED DRIVER EXTERNAL with the installed central battery system must be checked before installation.

LED DRIVER EXTERNAL can be operated on 220–240V at 0/50–60 Hz.



In an emergency (supply voltage at 0 Hz), LED DRIVER EXTERNAL operates LED TUBE EXTERNAL at 100 % luminous flux.

OPERATION ON DECENTRALIZED BATTERY SYSTEMS

LED TUBE EXTERNAL is a constant-current LED tube and can therefore be operated directly on a decentralized battery system.



















Compatibility and the required technical parameters of LED TUBE EXTERNAL must be checked by the installer prior to installation according to the applicable emergency lighting standards .

* Compatibility and the required technical parameters of LED TUBE EXTERNAL T5/T8 must be checked prior to installation according to the applicable emergency lighting standards. Compatibility of LED DRIVER EXTERNAL with the installed central battery system must be checked before installation.

3 CONVERSION

3.3 OPERATING DULUX LED ON MAINS VOLTAGE

PRODUCT FAMILY CFLni	PRODUCT IMAGE CFLni	▶	PRODUCT IMAGE LED	PRODUCT FAMILY LED
DULUX S G23		▶		DULUX LED S G23
DULUX D G24d		▶		DULUX LED D G24d
				DULUX LED VERTICAL G24d
DULUX T GX24d		▶		DULUX LED T GX24d
DULUX F 2G10		▶		DULUX LED F 2G10
DULUX SQ GR8		▶		DULUX LED SQ GR8
DULUX D/E G24q		▶		DULUX LED D/E G24q
DULUX L 2G11		▶		DULUX LED L 2G11
DULUX T/E GX24q		▶		DULUX LED T/E GX24q

Conversion must be carried out by a qualified electrician.

1. Please follow the five golden rules of electrical safety
2. Remove conventional CFLni lamp
3. Remove the control gear and capacitor for reactive power compensation
4. Convert the luminaire as per the circuit diagram
5. Insert DULUX LED in the lamp holder
6. Ensure that the converted luminaire complies with all the relevant legal requirements, safety regulations and technical standards, such as DIN VDE 0701-0702 and DIN EN 60598-1
7. The converted luminaire must be given a new type plate. The old type plate must be made unrecognizable



FIVE SAFETY RULES:

1. Disconnect from the mains.
2. Secure against reconnection.
3. Verify that there is no voltage.
4. Carry out earthing and short-circuiting.
5. Cover or block adjacent live parts.

After conversion, only DULUX LED tubes from LEDVANCE may be used in the luminaire and not CFLni lamps. We recommend installing a circuit breaker (250V, T2A) to protect the installation if a fluorescent lamp is installed again by accident. A LEDVANCE DULUX LED can be operated safely and in compliance with relevant standards without this additional circuit breaker.

3.3.1 LEDVANCE DULUX LED S EM

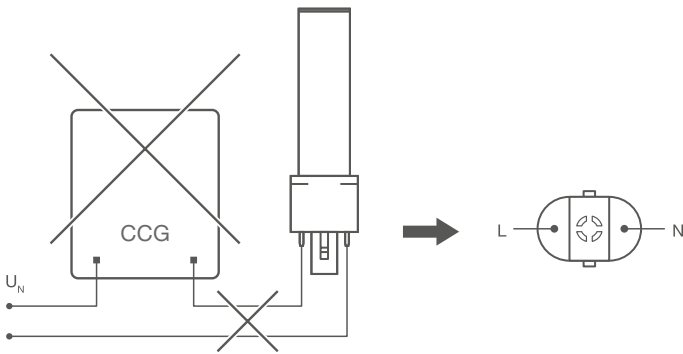

3.3.2 LEDVANCE DULUX LED D EM, D VERTICAL EM & T EM

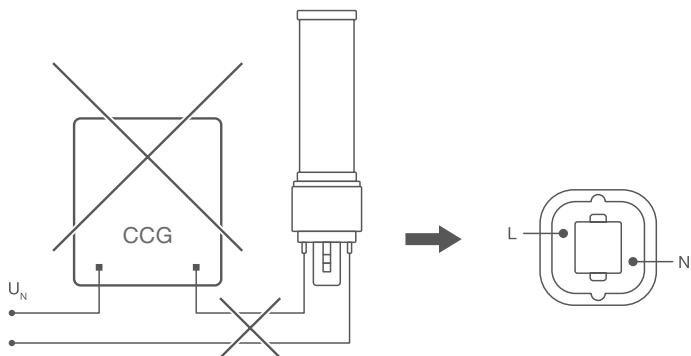

3.3.3 LEDVANCE DULUX LED F EM

LEDVANCE DULUX LED F EM 1 LAMP MAINS CONNECTION

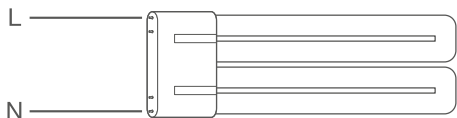

LEDVANCE DULUX LED F EM 2 LAMPS MAINS CONNECTION

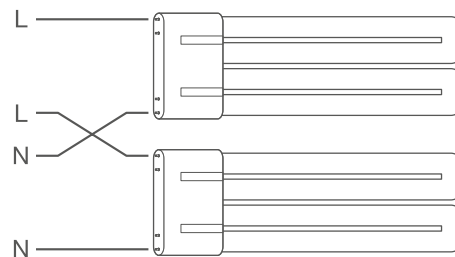

3.3.4 LEDVANCE DULUX LED SQ EM (SQUARE)

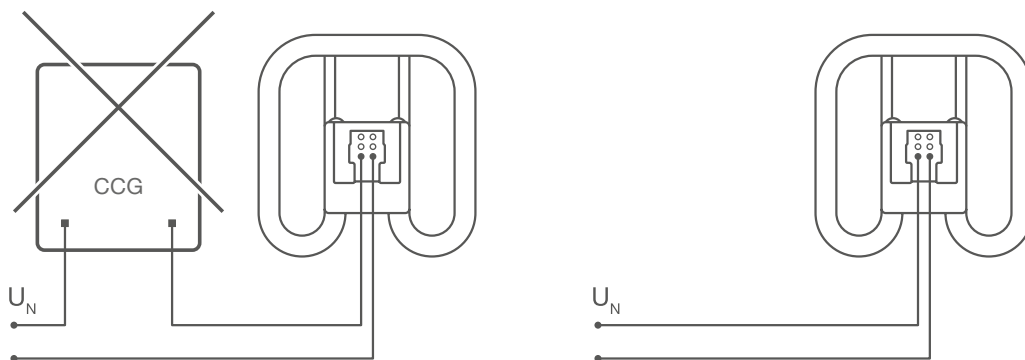

3.3.5 LEDVANCE DULUX LED D/E HF & T/E HF

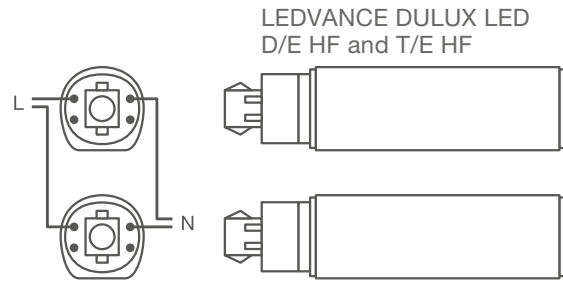
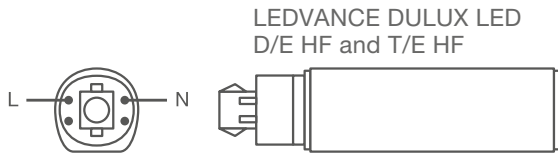

3.3.6 LEDVANCE DULUX LED L HF

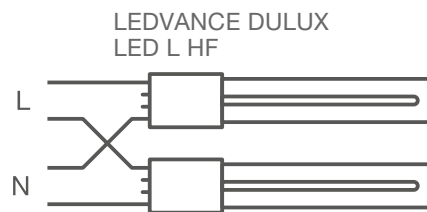
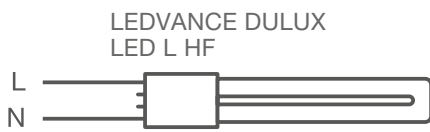

4 NOTES ON OPERATING TEMPERATURE

Since LED lamps are more sensitive to high ambient temperatures than conventional fluorescent lamps, we recommend you check that the ambient and casing temperatures (T_a and T_c) of the LED TUBE or DULUX LED from LEDVANCE are exceeded in the relevant application, especially in narrow, enclosed or multi-lamp luminaires. The T_c max temperature is the maximum permissible temperature on the surface of the lamp.

In multi-lamp luminaires the T_c temperature should be measured at each lamp in the luminaire. We recommend using a temperature gauge and a flexible thermal sensor.

The measurement is taken at the T_c point with the luminaire switched on. The maximum T_c temperature is reached after a burning time of 1 to 2 hours. Measurements should be taken under real ambient conditions. If the luminaire has a cover it must be in place when the measurement is taken. Adverse ambient conditions, such as seasonal temperature fluctuations (hot summer day) must be taken into account. If necessary, an extra thermal buffer should be provided.

EXAMPLE:

T_c measurement on installation => measured T_c temperature = 60 °C. In summer, the room temperature may be 10 °C higher => T_c temperature could rise to approx. 70 °C.

Please ensure that the maximum permissible T_a and T_c temperatures specified in the relevant data sheet are not exceeded. Exceeding these temperatures may lead to permanent damage to the LED TUBE or DULUX LED. For more information please refer to the data sheet.

NOTE:

LED TUBE UNIVERSAL has two T_c points: one for ECG (HF) operation and the other for CCG (EM)/mains operation.

ABOUT LEDVANCE



LEDVANCE

With subsidiaries in more than 50 countries and business activities in over 140 countries, LEDVANCE is one of the world's leading companies in the field of general lighting for professional customers and end users. Emerging from OSRAM's general lighting division, LEDVANCE's portfolio includes a wide range of LED luminaires for a variety of applications, intelligent lighting products for smart homes and smart buildings, one of the most comprehensive offerings of advanced LED lamps in the lighting industry, and traditional lamps. Beyond lighting, LEDVANCE offers vertically integrated, renewable energy solutions for the building sector. Together, the lighting division and the renewable energy division form a comprehensive ecosystem for residential, commercial, and industrial buildings. For more information, visit www.ledvance.com.

LEDVANCE GmbH
Parkring 1-5
85748 Garching
Germany
LEDVANCE.COM

Partner:



LEDVANCE.COM