

**The server returned a "500 Internal Server Error".**

Something is broken. Please let us know what you were doing when this error occurred. We will fix it as soon as possible. Sorry for any inconvenience caused.

# PRODUKTDATENBLATT

## PL COMP 600 V 33W 830

PANEL COMPACT 600 | Quadratische Einlege-Leuchten, für 600 x 600 mm Deckensysteme

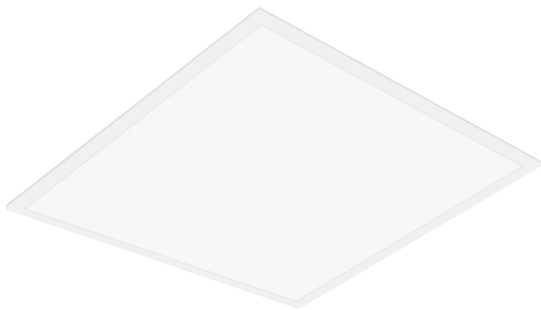

---

### Anwendungsgebiete

- Direkter Ersatz für Leuchten mit Leuchtstofflampen
- Büroräume, Konferenzräume
- Empfangsbereiche, Eingangsbereiche, Korridore, Aufzüge
- Geeignet für Deckeneinbausysteme mit einem Rastermaß von 600 x 600 mm

---

### Produktvorteile

- Flimmerarmes Licht dank speziellem elektronischen Vorschaltgerät
- Energieeinsparung dank Systemlichtausbeute von bis zu 110 lm/W
- Externer Treiber für erweiterte Flexibilität und einfache Installation
- Version mit DALI-EVG verfügbar
- 5 Jahre Garantie

---

### Produkteigenschaften

- Rahmen aus stranggepresstem Aluminium
- Polystyrol-Diffuser
- Lebensdauer (L80/B10): bis zu 50.000 h (bei 25 °C)

## Oops! An Error Occurred

**The server returned a "500 Internal Server Error".**

Something is broken. Please let us know what you were doing when this error occurred. We will fix it as soon as possible. Sorry for any inconvenience caused.

## The server returned a "500 Internal Server Error".

Something is broken. Please let us know what you were doing when this error occurred. We will fix it as soon as possible. Sorry for any inconvenience caused.

### TECHNISCHE DATEN

#### Elektrische Daten

Nennleistung	33,00 W
Nennspannung	220...240 V
Netzfrequenz	50...60 Hz
Nennstrom	150,000 mA
Einschaltstrom	12,3 A
Einschaltstromdauer $T_{h50}$	52 $\mu$ s
Max. Anzahl der Leuchten Leitungsschutzschalter B16	61
Max. Anz. Leucht. an Sicherungsaut. C10 A	48
Max. Anzahl der Leuchten Leitungsschutzschalter C16	78
Netzleistungsfaktor $\lambda$	> 0,90
Oberschwingungsgehalt	< 10 %
Schutzklasse	II
Betriebsart	Externer LED-Treiber

#### Photometrische Daten

Lichtstrom	3630 lm
Lichtausbeute	110 lm/W
Farbtemperatur	3000 K
Lichtfarbe (Bezeichnung)	Warm weiß
Farbwiedergabeindex Ra	> 80
Standardabweichung des Farbabgleichs	$\leq$ 5 sdc <sub>m</sub>
Flimmerarm	Ja
Flimmer-Messgröße (Pst LM)	<1
Messgröße für Stroboskop-Effekte (SVM)	< 0.4
Photobiologische Risikogruppe gemäß EN62778	RG0
Ausstrahlungswinkel	120 °

## Oops! An Error Occurred

### The server returned a "500 Internal Server Error".

Something is broken. Please let us know what you were doing when this error occurred. We will fix it as soon as possible. Sorry for any inconvenience caused.

## The server returned a "500 Internal Server Error".

Something is broken. Please let us know what you were doing when this error occurred. We will fix it as soon as possible. Sorry for any inconvenience caused.

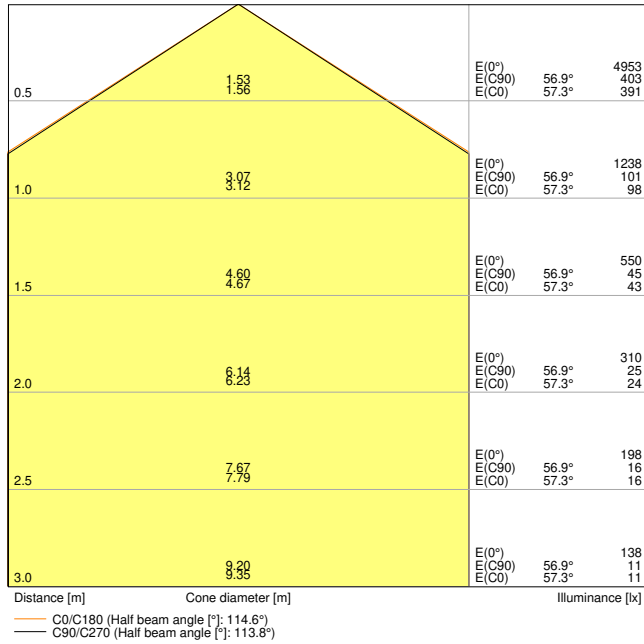

LDC typ cone

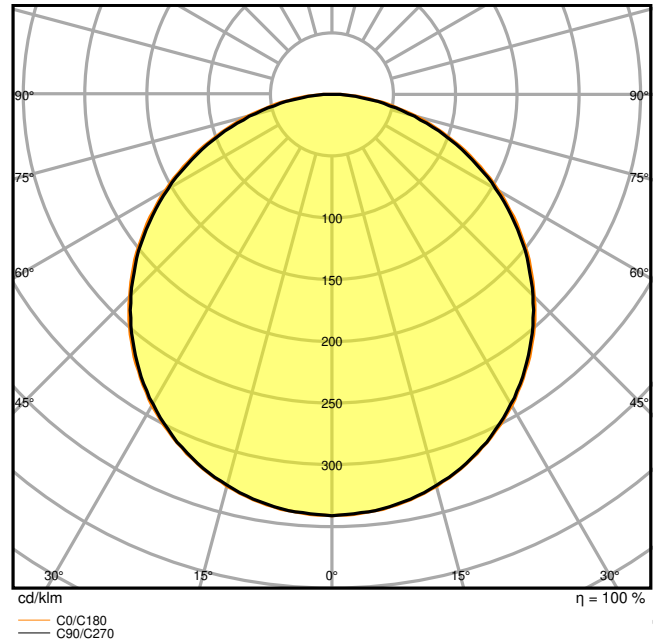

LDC typ polar

## Maße & Gewicht

Länge	595,00 mm
Breite	595,00 mm
Höhe	32,00 mm
Produktgewicht	1543,00 g

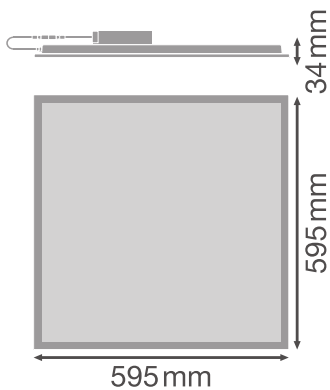

## Oops! An Error Occurred

The server returned a "500 Internal Server Error".

Something is broken. Please let us know what you were doing when this error occurred. We will fix it as soon as possible. Sorry for any inconvenience caused.

## The server returned a "500 Internal Server Error".

Something is broken. Please let us know what you were doing when this error occurred. We will fix it as soon as possible. Sorry for any inconvenience caused.

Produktfarbe	Weiß
Gehäusefarbe	Weiß
Gehäusematerial	Aluminium
Material Abdeckung	Polystyrol (PS)
Material der lichtemittierenden Fläche	Polystyrol
Glühdrahtprüfung nach IEC 60695-2-12	650 °C
Quecksilbergehalt der Lampe	0.0 mg

### Anwendung & Installation

Umgebungstemperaturbereich	-10...+45 °C
Lagertemperaturbereich	-20...+70 °C
Anschlussart	Schraubenlose-Anschlussklemme, 2-Pole (L, N)
Schutzart	IP40/IP20
Schutzklasse IK (Stoßfestigkeitsgrad)	IK02
Dimmbar	Nein
Montageart	Einbau/Abgehängt/Anbau
Montageort	Decke
Anwendungsumgebung	Innenanwendungen
Einbaulänge	575 mm
Einbaubreite	575 mm
Einbautiefe	50,0 mm
Justierbar	Nein
LED-Modul austauschbar	Nicht austauschbar
Mit Leuchtmittel	Ja

### Lebensdauer

Lebensdauer L70/B50 bei 25 °C	70000 h <sup>1)</sup>
Lebensdauer L80/B10 bei 25 °C	50000 h <sup>1)</sup>
Lebensdauer L90/B10 bei 25 °C	40000 h
Anzahl der Schaltzyklen	50000

<sup>1)</sup> t[h]: L70 / B50 @ 25 °C (Ta), t[h]: L80 / B10 @ 25 °C (Ta), t[h]: L90 / B10 @ 25 °C (Ta)

### Vorschaltgerät

Ausgangsstrom	700 mA
EVG - Ausgangs-Rippelstrom	< 7 %

## Oops! An Error Occurred

### The server returned a "500 Internal Server Error".

Something is broken. Please let us know what you were doing when this error occurred. We will fix it as soon as possible. Sorry for any inconvenience caused.

## The server returned a "500 Internal Server Error".

Something is broken. Please let us know what you were doing when this error occurred. We will fix it as soon as possible. Sorry for any inconvenience caused.

EVG - Breite	49.9 mm
EVG - Höhe	27 mm
Empfohlenes Vorschaltgerät	LEDV DR DALI-P-44/220-240/1050









### Zertifikate & Standards

Normen	CE / CB / TÜV / UKCA / EAC
Leuchte mit begrenzter Oberflächentemperatur "D-Zeichen"	Nein
Ballwurfsicher	Nein

### TECHNISCHE AUSSTATTUNG

- Zubehör für verschiedene Einbaumöglichkeiten erhältlich
- Sicherungsseil für Leuchten enthalten
- Sicherheitsklemmen vormontiert
- Externes Vorschaltgerät enthalten
- Geeignet für den Betrieb mit Emergency Conversion Box
- Anschlussbox mit 5-poliger Klemme zur Durchverdrahtung für Kabelquerschnitte bis zu 2,5 mm<sup>2</sup> separat erhältlich

### DOWNLOADS

Dokumente und Zertifikate	
	User instruction
	Addon Technical Information
	Packaging insert
	Declarations Of Conformity CE
	Declarations Of Conformity UKCA
Fotometrische und lichttechnische Planungsdateien	
	IES file (IES)
	LDT file (Eulumdat)
	ULD file (DIALux)







## Oops! An Error Occurred

### The server returned a "500 Internal Server Error".

Something is broken. Please let us know what you were doing when this error occurred. We will fix it as soon as possible. Sorry for any inconvenience caused.

## The server returned a "500 Internal Server Error".

Something is broken. Please let us know what you were doing when this error occurred. We will fix it as soon as possible. Sorry for any inconvenience caused.

	ROLF file (RELUX)
	UGR file (UGR table)
	LDC typ cone
	LDC typ polar
<b>CAD/BIM Dateien</b>	
	BIM_Revit_3D
	CAD_STEP_3D
<b>Ausschreibungstexte</b>	
	Ausschreibungstexte

## VERPACKUNGSMITTEL

EAN	Verpackungseinheit (Stück pro Einheit)	Abmessungen (Länge x Breite x Höhe)	Bruttogewicht	Volumen
4099854017742	Faltschachtel 1	602 mm x 37 mm x 662 mm	1973.00 g	14.75 dm <sup>3</sup>
4099854017759	Versandschachtel 4	677 mm x 164 mm x 628 mm	8802.00 g	69.73 dm <sup>3</sup>

Die genannten Produktnummern beschreiben die kleinste bestellbare Mengeneinheit. Eine Versandeinheit kann mehrere Einzelprodukte beinhalten. Als Bestellmenge verwenden Sie bitte das Ein- oder Mehrfache einer Versandeinheit.

## WEITERE KATALOGINFORMATIONEN

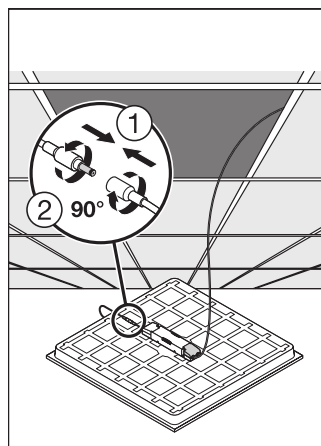
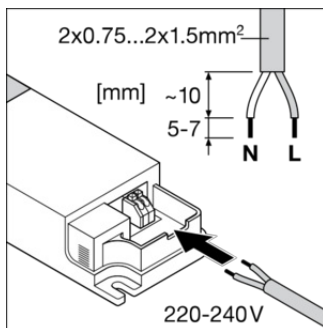

## Oops! An Error Occurred

The server returned a "500 Internal Server Error".

Something is broken. Please let us know what you were doing when this error occurred. We will fix it as soon as possible. Sorry for any inconvenience caused.

## **The server returned a "500 Internal Server Error".**

Something is broken. Please let us know what you were doing when this error occurred. We will fix it as soon as possible. Sorry for any inconvenience caused.

- Zur Garantie siehe [www.ledvance.de/garantie](http://www.ledvance.de/garantie)

---

### **Haftungsausschluss**

Änderungen und Irrtümer vorbehalten. Vergewissern Sie sich, dass Sie immer den neuesten Stand verwenden.

## **Oops! An Error Occurred**

### **The server returned a "500 Internal Server Error".**

Something is broken. Please let us know what you were doing when this error occurred. We will fix it as soon as possible. Sorry for any inconvenience caused.