



CorePro LED PLC 2P



CorePro LED PLC 8.5W 830 2P G24d-3

De Philips CorePro LED PL-C integreert LED technologie in een traditionele fluorescentie-lampvorm. Dit product vormt een simpel retrofit-alternatief voor algemene verlichting: het voldoet aan de basiseisen voor verlichting, biedt significante besparingen op energieverbruik en is milieuvriendelijk.

Product gegevens

| Algemene informatie | |
|--------------------------------|------------------|
| Lampvoet | G24D-3 [G24d-3] |
| CE-markering | Ja |
| Conform EU RoHS-richtlijn | Ja |
| Nominale levensduur (nom.) | 30000 h |
| Schakelcyclus | 50000 |
| Meetreferentie van lichtstroom | Sphere |
| Laag | CorePro |

| Eisen aan armatuurontwerp | |
|---|---------------------|
| Kleurcode | 830 [CCT of 3000K] |
| Bundelhoek (nom.) | 120 ° |
| Lichtstroom (nom.) | 950 lm |
| Kleuraanduiding | Wit (WH) |
| Gecorreleerde kleurtemperatuur (nom.) | 3000 K |
| Lichtrendement (gespec.) (nom.) | 105,88 lm/W |
| Kleurconsistentie | <6 |
| Kleurweergave-index (nom.) | 83 |
| LLMF bij einde nominale levensduur (nom.) | 70 % |

| Bedrijfs- en elektrische gegevens | |
|-----------------------------------|--------------|
| Ingangsfrequentie | 50 tot 60 Hz |
| Power (Rated) (Nom) | 8,5 W |

| | |
|--|-----------|
| Lampstroom (max.) | 43 mA |
| Lampstroom (min.) | 33 mA |
| Opstarttijd (nom.) | 0,5 s |
| Opwarmtijd tot 60% lichtopbrengst (nom.) | 0,5 s |
| Arbeidsfactor (nom.) | 0,9 |
| Spanning (nom.) | 220-240 V |

| Temperatuur | |
|-----------------------------|--------|
| T-omgeving (max.) | 35 °C |
| T-omgeving (min.) | -20 °C |
| T-opslag (max.) | 65 °C |
| T-opslag (min.) | -40 °C |
| T-behuizing maximaal (nom.) | 75 °C |

| Regelsystemen en dimmers | |
|--------------------------|-----|
| Dimbaar | Nee |

| Mechanische eigenschappen en behuizing | |
|--|-------------------|
| Lampmateriaal | Kunststof |
| Productlengte | 200 mm |
| Lampvorm | Buis, enkelkneeps |

CorePro LED PLC 2P

Goedkeuring en toepassing

| | |
|-------------------------------|---|
| Energie-efficiëntieklasse | F |
| Energiebesparend product | Yes |
| Goedkeuringsmerktekens | TÜV CE-markering RoHS compliance KEMA Keur-certificaat |
| Energieverbruik kWh/1.000 uur | 9 kWh |
| EPREL-registratienummer | 403554 |

Productgegevens

| | |
|-----------------------------|------------------------------------|
| Volledige productcode | 871869654123400 |
| Productnaam voor bestelling | CorePro LED PLC 8.5W 830 2P G24d-3 |

| | |
|----------------------------------|------------------------------------|
| EAN/UPC - Product | 8718696541234 |
| Bestelcode | 54123400 |
| Lokale code | CPLC8.5W830D3 |
| Numerator - Aantal per pak | 1 |
| Beschrijving lokale code | CorePro LED PLC 8.5W 830 2P G24d-3 |
| Numerator - Dozen per buitendoos | 10 |
| SAP-materiaal | 929001201202 |
| Net Weight (Piece) | 0,090 kg |

Maatschets

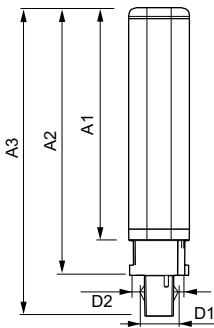

CorePro LED PLC 8.5W 830 2P G24d-3

| Product | D1 | D2 | A1 | A2 | A3 |
|---------------------------------------|---------|---------|----------|--------|----------|
| CorePro LED PLC 8.5W 830 2P G24d-3 | 24,3 mm | 28,4 mm | 128,8 mm | 148 mm | 170,6 mm |

Fotometrische gegevens

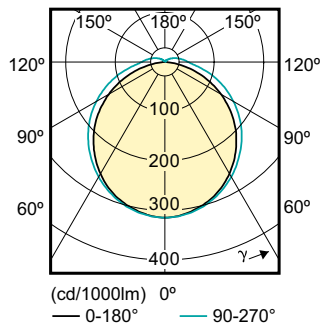
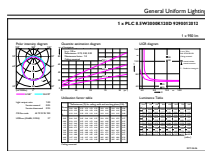

LEDtube PLC 100mm 9W G24D-3 830 950lm

CorePro LED PLC 2P

Fotometrische gegevens

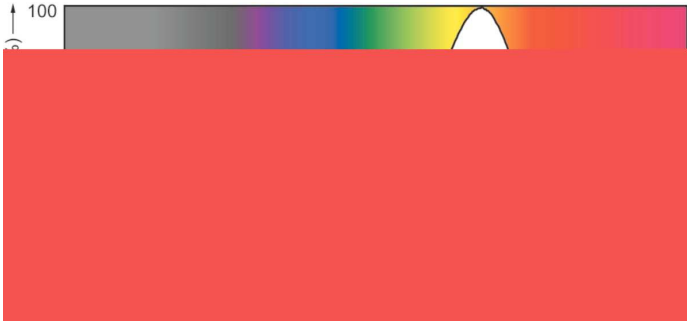

Levensduur

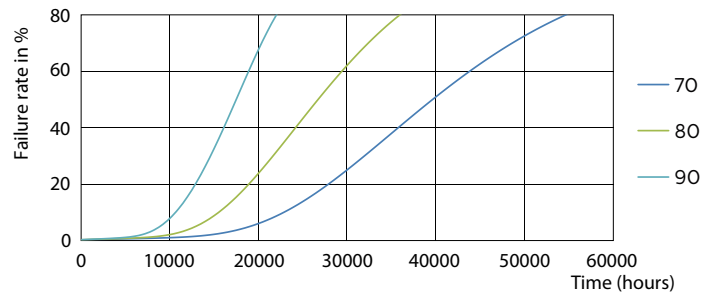
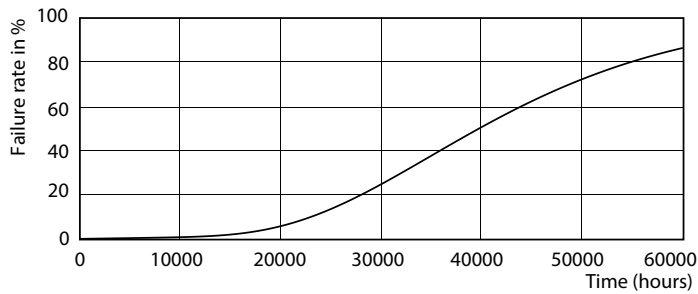

LEDtube PLC 100mm 9W G24D-3 830 950lm

LEDtube PLC 100mm 9W G24D-3 830 950lm

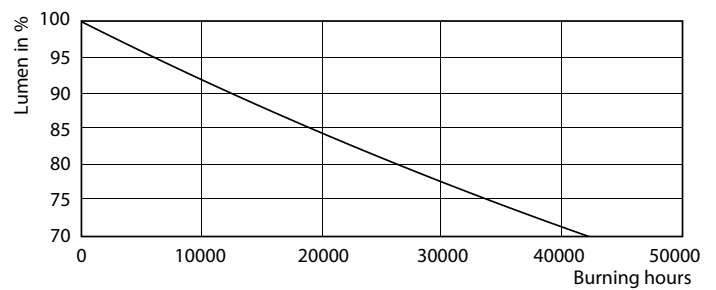

LEDtube PLC 100mm 9W G24D-3 830 950lm

LEDtube PLC 100mm 9W G24D-3 830 950lm

CorePro LED PLC 2P

Levensduur

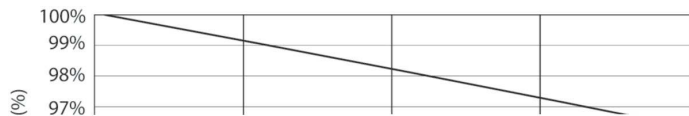

LEDtube PLC 100mm 9W G24D-3 830 950lm

