



# CorePro LED PLC 2P



## CorePro LED PLC 6.5W 840 2P G24d-2

De Philips CorePro LED PL-C integreert LED technologie in een traditionele fluorescentie-lampvorm. Dit product vormt een simpel retrofit-alternatief voor algemene verlichting: het voldoet aan de basiseisen voor verlichting, biedt significante besparingen op energieverbruik en is milieuvriendelijk.

### Product gegevens

Algemene informatie	
Lampvoet	G24D-2 [ G24d-2]
CE-markering	Ja
Conform EU RoHS-richtlijn	Ja
Nominale levensduur (nom.)	30000 h
Schakelcyclus	50000
Meetreferentie van lichtstroom	Sphere
Laag	CorePro

Eisen aan armatuurontwerp	
Kleurcode	840 [ CCT of 4000K (841)]
Bundelhoek (nom.)	120 °
Lichtstroom (nom.)	700 lm
Kleuraanduiding	Koel Wit (CW)
Gecorreleerde kleurtemperatuur (nom.)	4000 K
Lichtrendement (gespec.) (nom.)	92,31 lm/W
Kleurconsistentie	<6
Kleurweergave-index (nom.)	83
LLMF bij einde nominale levensduur (nom.)	70 %

Bedrijfs- en elektrische gegevens	
Ingangsfrequentie	50 tot 60 Hz
Power (Rated) (Nom)	6,5 W

Lampstroom (max.)	35 mA
Lampstroom (min.)	25 mA
Opstarttijd (nom.)	0,5 s
Opwarmtijd tot 60% lichtopbrengst (nom.)	0,5 s
Arbeidsfactor (nom.)	0,9
Spanning (nom.)	220-240 V

Temperatuur	
T-omgeving (max.)	35 °C
T-omgeving (min.)	-20 °C
T-opslag (max.)	65 °C
T-opslag (min.)	-40 °C
T-behuizing maximaal (nom.)	65 °C

Regelsystemen en dimmers	
Dimbaar	Nee

Mechanische eigenschappen en behuizing	
Lampmateriaal	Kunststof
Productlengte	100 mm
Lampvorm	Buis, enkelkneeps

# CorePro LED PLC 2P

## Goedkeuring en toepassing

Energie-efficiëntieklasse	F
Energiebesparend product	Yes
Goedkeuringsmerktekens	TÜV CE-markering RoHS compliance KEMA Keur-certificaat
Energieverbruik kWh/1.000 uur	7 kWh
EPREL-registratienummer	403557

## Productgegevens

Volledige productcode	871869654129600
-----------------------	-----------------

Productnaam voor bestelling	CorePro LED PLC 6.5W 840 2P G24d-2
EAN/UPC - Product	8718696541296
Bestelcode	54129600
Lokale code	CPLC6.5W840D2
Numerator - Aantal per pak	1
Numerator - Dozen per buitendoos	10
SAP-materiaal	929001201502
Net Weight (Piece)	0,077 kg

## Maatschets



Product	D1	D2	A1	A2	A3
CorePro LED PLC 6.5W 840 2P G24d-2	24,3 mm	28,4 mm	105,8 mm	125 mm	147,6 mm

## CorePro LED PLC 6.5W 840 2P G24d-2

## Fotometrische gegevens

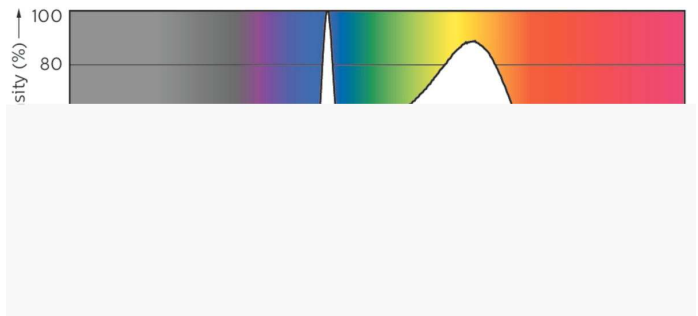
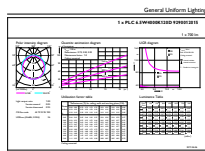

## LEDtube PLC 100mm 7W G24D-2 840 700lm

## LEDtube PLC 100mm 9W G24Q-3 840 1000lm

# CorePro LED PLC 2P

## Fotometrische gegevens

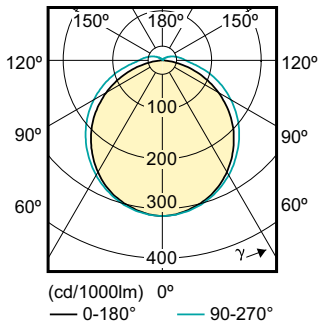

## Levensduur

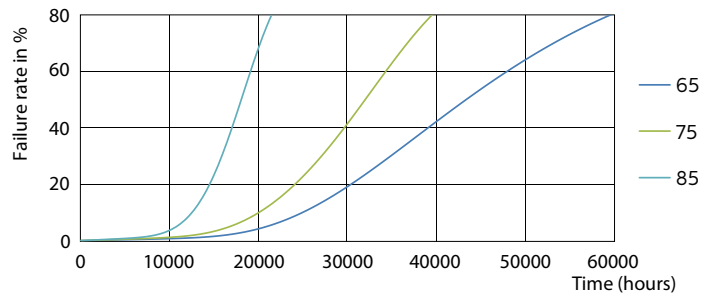
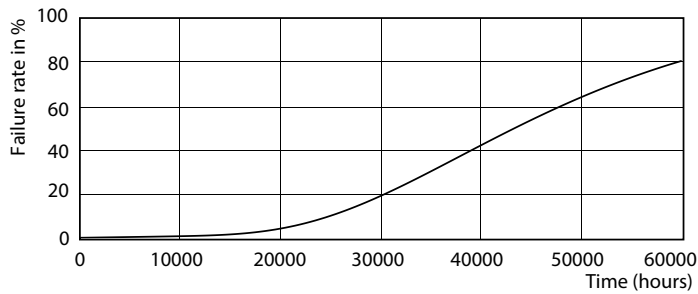

LEDtube PLC 100mm 7W G24D-2 830 650lm

LEDtube PLC 100mm 7W G24D-2 830 650lm

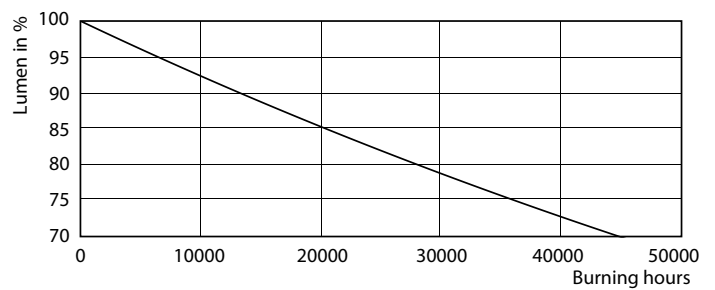
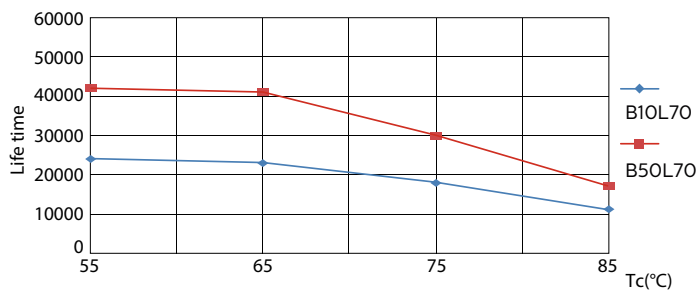

LEDtube PLC 100mm 7W G24D-2 830 650lm

LEDtube PLC 100mm 7W G24D-2 830 650lm

## CorePro LED PLC 2P

### Levensduur

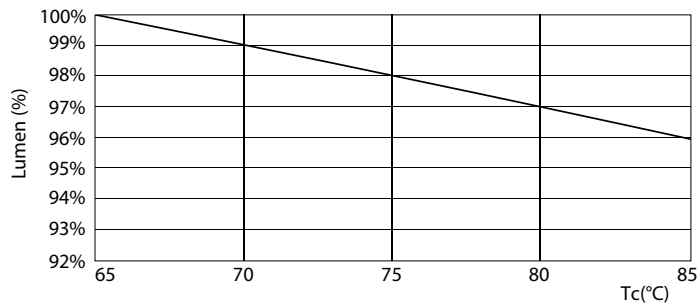

LEDtube PLC 100mm 7W G24D-2 830 650lm

