

IP 55

class I

IK07 2J xx5
IK10 20J xx9
IK06 1J xx3



MAGICCLICK

design Roberto Fiorato

Serie wand-, beugel-, mast- en plafondarmaturen voor zowel binnen als buiten, bestaande uit:

- behuizing, ring en visa scherm (Magiclick 18) van spuitgietaluminium
- afscherming van geperd glas, van binnen gesatineerd
- Schuimsiliconen pakking
- Schroeven van roestvrij staal
- De ring en het glas vormen een geheel
- Openingsysteem met scharnieren om de installatie en het onderhoud gemakkelijker te maken.
- PC versies met afscherming van polycarbonaat zijn vandalismebestendig (alleen fluorescentie)
- zijaansluiting door middel van buis max diameter 20 mm mogelijk
- De versies C zijn voorzien van een schemerschakelaar
- Sensor geschikt zowel voor inductieve als ohmse belasting
- Instelbaar van 5 lux tot 300 lux
- De versie EM/3P kan als algemene verlichting en als noodverlichting gebruikt worden
- Ni-Cd 3,6V 4 Ah batterijen, autonomie 3 uur, oplaadtijd 24 uur

Série d'appareils pour installation en applique, au plafond, sur console et sur poteaux pour intérieur et extérieur, en trois dimensions, composée de:

- Boîtier, cercle et écran visa (Magiclick 18) en aluminium moulé sous pression peint
- Diffuseur en verre pressé satiné intérieurement
- Joint en polymère expansé
- Vis de fermeture en acier inoxydable
- Cercle et verre solidaires entre eux
- Système d'ouverture à charnière pour faciliter l'installation et la manutention
- Possibilité d'alimentation avec tube de diamètre 20 mm maximum
- Versions PC avec diffuseur en technopolymère opale antivandale (seulement fluorescence PC)
- Les versions C crépusculaires sont équipées d'un capteur pour déclenchement automatique
- Capteur idéal pour charge inductive et pour charge résistive
- Seuil de détection réglable de 5 lux à 300 lux
- La version EM/3P est prévue pour être utilisée en éclairage général ainsi que en cas d'urgence
- Accumulateurs Ni-Cd 3,6V 4 Ah, autonomie de trois heures, temps de recharge 24 heures
- Résistance au fil incandescent 960° C 5° sec. (NF EN 60695-2-11:2001)



DOUILLE COULEURCLASSE COS φ CODE NOTE
 LAMPHOUDER W ILCOS KLEUR KLASSE KELVIN ≥ 0,9 EEI BESTELNR. AANTEKEN. EURO



MAGICLICK 20

E27	max 1x75w	IAA	WH1	I	•			004912		54,00
E27	max 1x75w	IAA	GR3	I	•			004913		54,00
E27	max 1x75w	IAA	AN3	I	•			004911		54,00
Fluorescentie-elektronische ballast-vsa 220/240V 50/60Hz/Fluorescentes-ballast électronique 220/240V 50/60Hz										
GX24q-2	1x18w	FSM	WH1	I	•	2700	A2÷A3	054918		93,00
GX24q-2	1x18w	FSM	GR3	I	•	2700	A2÷A3	054919		93,00
GX24q-2	1x18w	FSM	AN3	I	•	2700	A2÷A3	054917		93,00



IK07 2J xx5

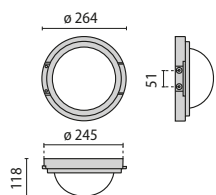

E27
max 1x75W



E27
1x12W Dulux EL Longlife
1x14W Osram Dulux EL Facility
1x15W Dulux EL Longlife
1x15W Philips PL-E
1x23W Megaman MM 333
1x15W GE FLE



GX24q-2
1x18W



RACCORDEMENT EN CASCADE
AVEC UN TUBE Ø 20
VERBINDING IN CASCADE
MET BUIS Ø 20



MAGICLICK 20 PC

Fluorescentie-elektronische ballast-vsa 220/240V 50/60Hz/Fluorescentes-ballast électronique 220/240V 50/60Hz										
GX24q-2	1x18w	FSM	WH1	I	•	2700	A2÷A3	054921		93,00
GX24q-2	1x18w	FSM	GR3	I	•	2700	A2÷A3	054922		93,00
GX24q-2	1x18w	FSM	AN3	I	•	2700	A2÷A3	054920		93,00



IK10 20J xx9

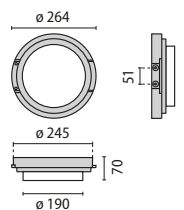

GX24q-2
1x18W



IK10 20J



RACCORDEMENT EN CASCADE
AVEC UN TUBE Ø 20
VERBINDING IN CASCADE
MET BUIS Ø 20

DIMENSIONS EMBALLAGE / AFMETINGEN VERPAKKING

ENTRAXES DE FIXATION / ASMATEN VOOR INSTALLATIE

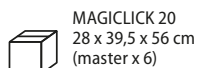

MAGICLICK 20
28 x 39,5 x 56 cm
(master x 6)



MAGICLICK 20 PC
28 x 24,8 x 56 cm
(master x 6)

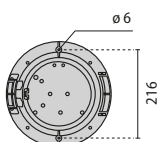

WH1
BLANC
WIT



GR3
GRIS MÉT.SATINÉ
GRIJS METALLIC MAT



AN3
ANTHRACITE MÉT. SATINÉ
ANTRACIET METALLIC MAT

De aanwezigheid van de gegevens betreffende de Kelvingraden, betekent dat de lamp is inbegrepen.
 La présence de la donnée relative aux degrés Kelvin indique que la lampe est comprise.

raccordement en cascade / verbinding in cascade

IP 55

class I

IK07 2J xx5
IK10 20J xx9
IK06 1J xx3

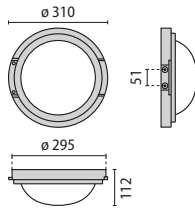

MAGICLICK 25

E27	max 1x100w	IAA	WH1	I	•			004924	⁴ / ₄	58,00
E27	max 1x100w	IAA	GR3	I	•			004925	⁴ / ₄	58,00
E27	max 1x100w	IAA	AN3	I	•			004923	⁴ / ₄	58,00



Fluorescentie-elektronische ballast-vsa 220/240V 50/60Hz/Fluorescentes-ballast électronique 220/240V 50/60Hz

G24q-3	1x26w	FSQ	WH1	I	•	2700	•	A2	054930	⁴ / ₄	95,50
G24q-3	1x26w	FSQ	GR3	I	•	2700	•	A2	054931	⁴ / ₄	95,50
G24q-3	1x26w	FSQ	AN3	I	•	2700	•	A2	054929	⁴ / ₄	95,50

Fluorescentie- magnetische ballast-vsa 230V 50Hz/Fluorescentes-ballast magnétique 230V 50Hz

GR10q	1x21w	TC-DD	WH1	I		2700		≤B2	004927	⁴ / ₄	95,50
GR10q	1x21w	TC-DD	GR3	I		2700		≤B2	004928	⁴ / ₄	95,50
GR10q	1x21w	TC-DD	AN3	I		2700		≤B2	004926	⁴ / ₄	95,50

IK07 2J xx5

E27	E27	G24q-3	GR10q
max 1x100W	1x23W Dulux EL Longlife 1x23W Philips PL-E 1x24W Dulux EL Longlife 1x23W Megaman MM 333 1x23W GE FLE	1x26W	1x21W



MAGICLICK 25 EM/3P



Noodverlichting- elektronische ballast-vsa/Secours-ballast électronique

GX24q-1	1x13w	FSM	WH1	I		2700		A2÷A3	004884	³ / ₄	264,00
GX24q-1	1x13w	FSM	GR3	I		2700		A2÷A3	004885	³ / ₄	264,00
GX24q-1	1x13w	FSM	AN3	I		2700		A2÷A3	004886	³ / ₄	264,00

IK07 2J xx5

GX24q-1
1x13W

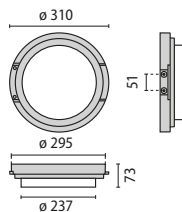

MAGICLICK 25 PC



Fluorescentie-elektronische ballast-vsa 220/240V 50/60Hz/Fluorescentes-ballast électronique 220/240V 50/60Hz

G24q-3	1x26w	FSQ	WH1	I	•	2700	•	A2	054933	⁴ / ₄	95,50
G24q-3	1x26w	FSQ	GR3	I	•	2700	•	A2	054934	⁴ / ₄	95,50
G24q-3	1x26w	FSQ	AN3	I	•	2700	•	A2	054932	⁴ / ₄	95,50

IK10 20J xx9

G24q-3
1x26W

MAGICLICK 25 PC EM/3P



Noodverlichting- elektronische ballast-vsa/Secours-ballast électronique

GX24q-1	1x13w	FSM	WH1	I		2700		A2÷A3	004887	³ / ₄	264,00
GX24q-1	1x13w	FSM	GR3	I		2700		A2÷A3	004888	³ / ₄	264,00
GX24q-1	1x13w	FSM	AN3	I		2700		A2÷A3	004889	³ / ₄	264,00

IK10 20J xx9

GX24q-1
1x13W



DOUILLE LAMPHOUDER W COULEURCLASSE ILCOS KLEUR KLASSE KELVIN ≥ 0,9 EEI CODE BESTELNR. NOTE AANTEKEN. EURO



MAGICLICK 18

E27	max 1x75w	IAA	WH1	I	•			004891		52,50
E27	max 1x75w	IAA	GR3	I	•			004892		52,50
E27	max 1x75w	IAA	AN3	I	•			004890		52,50

Fluorescentie-elektronische ballast-vsa 220/240V 50/60Hz/Fluorescentes-ballast électronique 220/240V 50/60Hz



GX24q-2	1x18w	FSM	WH1	I	•	2700	A2÷A3	054894		83,50
GX24q-2	1x18w	FSM	GR3	I	•	2700	A2÷A3	054895		83,50
GX24q-2	1x18w	FSM	AN3	I	•	2700	A2÷A3	054893		83,50

IK06 1J xx3



E27
max 1x75W



E27
1x14W Osram Dulux EL Facility
1x15W Dulux EL Longlife
1x16W Dulux EL Longlife
1x20W Philips PL-E
1x23W Megaman MM 333
1x15W GE FLE



GX24q-2
1x18W



RACCORDEMENT EN CASCADE
AVEC UN TUBE Ø 20
VERBINDING IN CASCADE
MET BUIS Ø 20

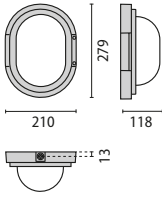

MAGICLICK 18 PC

Fluorescentie-elektronische ballast-vsa 220/240V 50/60Hz/Fluorescentes-ballast électronique 220/240V 50/60Hz



G24q-1	1x13w	FSQ	WH1	I	•	2700	A2÷A3	054897		83,50
G24q-1	1x13w	FSQ	GR3	I	•	2700	A2÷A3	054898		83,50
G24q-1	1x13w	FSQ	AN3	I	•	2700	A2÷A3	054896		83,50

IK10 20J xx9



G24q-1
1x13W



RACCORDEMENT EN CASCADE
AVEC UN TUBE Ø 20
VERBINDING IN CASCADE
MET BUIS Ø 20



IK10 20J

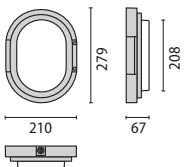

DIMENSIONS EMBALLAGE / AFMETINGEN VERPAKKING

ENTRAXES DE FIXATION / ASMATEN VOOR INSTALLATIE

MAGICLICK 25
32,5 x 37,4 x 65,5 cm
(master x 6)

MAGICLICK 18
23 x 39,5 x 59 cm
(master x 6)

MAGICLICK 25 PC
32,5 x 65,5 x 27,3 cm
(master x 6)

MAGICLICK 18 PC
24,5 x 23 x 59 cm
(master x 6)

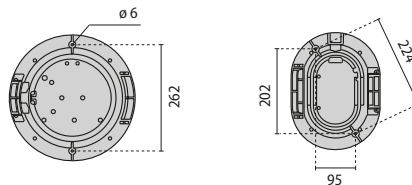

WH1
BLANC
WIT



GR3
GRIS MÉT.SATINÉ
GRIJS METALLIC MAT



AN3
ANTHRACITE MÉT. SATINÉ
ANTRACIET METALLIC MAT

raccordement en cascade / verbinding in cascade

IP 55

class I

IK07 2J xx5
IK10 20J xx9
IK06 1J xx3

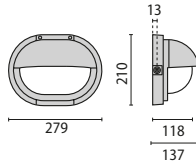

RRR
RACCORDEMENT EN CASCADE
AVEC UN TUBE Ø 20
VERBINDING IN CASCADE
MET BUIS Ø 20

MAGICLICK 18 VISA

E27	max 1x75w	IAA	WH1	I	•			004900	⁴	57,00
E27	max 1x75w	IAA	GR3	I	•			004901	⁴	57,00
E27	max 1x75w	IAA	AN3	I	•			004899	⁴	57,00



Fluorescentie-elektronische ballast-vsa 220/240V 50/60Hz/Fluorescentes-ballast électronique 220/240V 50/60Hz

GX24q-2	1x18w	FSM	WH1	I	•	2700	A2÷A3	054903	⁴	89,00
GX24q-2	1x18w	FSM	GR3	I	•	2700	A2÷A3	054904	⁴	89,00
GX24q-2	1x18w	FSM	AN3	I	•	2700	A2÷A3	054902	⁴	89,00



MAGICLICK 18 VISA/C

Fluorescentie-elektronische ballast-vsa 220/240V 50/60Hz/Fluorescentes-ballast électronique 220/240V 50/60Hz

2G7	1x9w	FSD	WH1	I		2700	A2÷A3	3007785		158,50
2G7	1x9w	FSD	GR3	I		2700	A2÷A3	3007795		159,00
2G7	1x9w	FSD	AN3	I		2700	A2÷A3	3007805		158,50

IK06 1J xx3



E27
max 1x75W



E27
1x14W Osram Dulux EL Facility
1x15W Dulux EL Longlife
1x16W Dulux EL Longlife
1x20W Philips PL-E
1x23W Megaman MM 333
1x15W GE FLE



GX24q-2
1x18W



2G7
1x9W

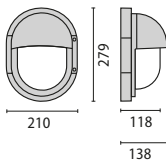

RRR
RACCORDEMENT EN CASCADE
AVEC UN TUBE Ø 20
VERBINDING IN CASCADE
MET BUIS Ø 20

MAGICLICK 18 VISA V

E27	max 1x75w	IAA	WH1	I	•			004906	⁴	57,00
E27	max 1x75w	IAA	GR3	I	•			004907	⁴	57,00
E27	max 1x75w	IAA	AN3	I	•			004905	⁴	57,00



Fluorescentie-elektronische ballast-vsa 220/240V 50/60Hz/Fluorescentes-ballast électronique 220/240V 50/60Hz

GX24q-2	1x18w	FSM	WH1	I	•	2700	A2÷A3	054909	⁴	89,00
GX24q-2	1x18w	FSM	GR3	I	•	2700	A2÷A3	054910	⁴	89,00
GX24q-2	1x18w	FSM	AN3	I	•	2700	A2÷A3	054908	⁴	89,00



MAGICLICK 18 VISA V/C

Fluorescentie-elektronische ballast-vsa 220/240V 50/60Hz/Fluorescentes-ballast électronique 220/240V 50/60Hz

2G7	1x9w	FSD	WH1	I		2700	A2÷A3	3007815		160,00
2G7	1x9w	FSD	GR3	I		2700	A2÷A3	3007825		160,00
2G7	1x9w	FSD	AN3	I		2700	A2÷A3	3007835		160,00

IK06 1J xx3



E27
max 1x75W



E27
1x14W Osram Dulux EL Facility
1x15W Dulux EL Longlife
1x16W Dulux EL Longlife
1x20W Philips PL-E
1x23W Megaman MM 333
1x15W GE FLE



GX24q-2
1x18W



2G7
1x9W

DIMENSIONS EMBALLAGE / AFMETINGEN VERPAKKING

ENTRAXES DE FIXATION / ASMATEN VOOR INSTALLATIE

MAGICLICK 18 VISA
29 x 45,5 x 44,5 cm
(master x 6)

MAGICLICK 18 VISA V
29 x 45,5 x 44,5 cm
(master x 6)

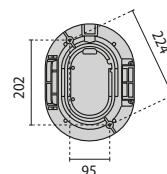

De aanwezigheid van de gegevens betreffende de Kelvingraden, betekent dat de lamp is inbegrepen.
La présence de la donnée relative aux degrés Kelvin indique que la lampe est comprise.

MAGICCLICK 18

ACCESSOIRES

Serie mastjes bestemd voor de montage van een of twee armaturen in rechte positie en één enkele in hellende positie, bestaande uit

- Mast van gelakt geëxtrudeerd aluminium
- Bodemplaat van gelakt spuitgietaluminium voor bevestiging aan de grond

ACCESSOIRES

Série de poteaux pour 1 ou 2 appareils en installation verticale, et un seul appareil en installation inclinée à 45°

- Poteau en aluminium extrudé et peint
- Embase en aluminium moulé sous pression et peint

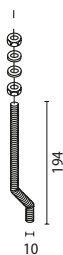

008981

DESCRIPTION / BESCHRIJVING

COULEUR
KLEUR

CODE
BESTELNR.

EURO

Mast D1 1155/Poteaux D1 1155	GR3	000508	89,00
Mast D1 1155/Poteaux D1 1155	AN3	000509	89,00
Mast D1 770/Poteaux D1 770	GR3	000511	75,50
Mast D1 770/Poteaux D1 770	AN3	000512	75,50
Mast D2 1155/Poteaux D2 1155	GR3	000514	89,00
Mast D2 1155/Poteaux D2 1155	AN3	000515	89,00
Mast D2 770/Poteaux D2 770	GR3	000517	78,50
Mast D2 770/Poteaux D2 770	AN3	000518	78,50
Mast incl. 1075/Poteaux incl. 1075	GR3	000523	96,50
Mast incl. 1075/Poteaux incl. 1075	AN3	000524	96,50
Mast incl. 690/Poteaux incl. 690	GR3	000526	81,00
Mast incl. 690/Poteaux incl. 690	AN3	000527	81,00
Draadeind/Tige De Scellement		008981	4,30
Antivandalen kit/ Kit antivandale		000839	3,20

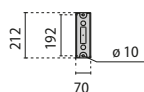

144

805

000511
000512

144

1193

000508
000509

264

805

000517
000518

264

1193

000514
000515

288

702

000526
000527

288

1089

000523
000524

000839



WH1
BLANC
WIT



GR3
GRIS MÉT. SATINÉ
GRIS METALLIC MAT



AN3
ANTHRACITE MÉT. SATINÉ
ANTHRACIET METALLIC MAT

IP 65

class I

IK08 5J xx5



MAGICCLICK 50

design Roberto Fiorato

Plafond- en wandarmatuur voor binnen of buiten bestaande uit:

- behuizing en ring van gepoedercoat spuitgietaluminium
- afscherming van geperst glas, binnenkant gesatineerd
- Schuimsiliconen pakking
- Schroeven van roestvrij staal
- Ring en glas vormen een geheel
- Installatie- en onderhoudsvriendelijk scharnierend openingsysteem
- Voorbewerkte kabel-buis zijinvoer diameter van max. 20 mm

- De versie EM/3P kan als algemene verlichting gebruikt worden
- Ni-Cd 3,6V 4 Ah batterijen, autonomie 3 uur, oplaadtijd 24 uur

Applique et plafonnier de puissance pour intérieur et extérieur composée de:

- Boîtier et cercle en aluminium moulé sous pression et peint
- Diffuseur en verre pressé peint à l'intérieur
- Joint en polymère expansé
- Vis de fermeture en acier inox
- Anneau et verre solidaires
- Système d'ouverture à charnière pour faciliter l'installation et l'entretien
- Possibilité d'alimentation avec un tube (diamètre maximal 20 mm)

- La version EM/3P est prévue pour être utilisée en éclairage général ainsi que en cas d'urgence
- Accumulateurs Ni-Cd 3,6V 4 Ah, autonomie de trois heures, temps de recharge 24 heures
- "Résistance au fil incandescent 960°C 5 sec. (NF EN 60695-2-11:2001)



DOUILLE LAMPHOUDER W COULEURCLASSE ILCOS KLEUR KLASSE KELVIN ≥ 0,9 COS φ EEI CODE BESTELNR. NOTE AANTEKEN. EURO



MAGICLICK 50

Fluorescentie-elektronische ballast-vsa 220/240V 50/60Hz/Fluorescentes-ballast électronique 220/240V 50/60Hz



2G10	2x36w	FSS	WH1	I	•	•	A2	004863		277,00
2G10	2x36w	FSS	GR3	I	•	•	A2	004864		277,00
2G10	2x36w	FSS	AN3	I	•	•	A2	004865		277,00
2GX13	1x55w	FSC	WH1	I	•	•	A2	004869		277,00
2GX13	1x55w	FSC	GR3	I	•	•	A2	004870		277,00
2GX13	1x55w	FSC	AN3	I	•	•	A2	004871		277,00
2GX13+	1x22w +	FSC								
2GX13	1x40w	FSC	WH1	I	•	•	A2	004866		277,00
2GX13+	1x22w +	FSC								
2GX13	1x40w	FSC	GR3	I	•	•	A2	004867		277,00
2GX13+	1x22w +	FSC								
2GX13	1x40w	FSC	AN3	I	•	•	A2	004868		277,00

IK08 5J xx5



RACCORDEMENT EN CASCADE AVEC UN TUBE Ø 20
VERBINDING IN CASCADE MET BUIS Ø 20

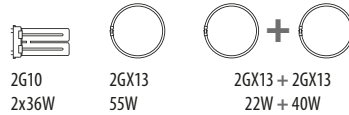
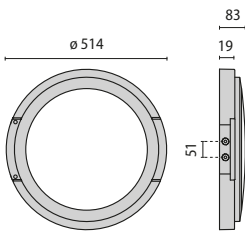

MAGICLICK 50 EM/3P

Noodverlichting- elektronische ballast-vsa/Secours-ballast électronique



2GX13	1x40w	FSC	WH1	I	•	•	A2	004872			421,50
2GX13	1x40w	FSC	GR3	I	•	•	A2	004873			421,50
2GX13	1x40w	FSC	AN3	I	•	•	A2	004874			421,50

IK08 5J xx5



RACCORDEMENT EN CASCADE AVEC UN TUBE Ø 20
VERBINDING IN CASCADE MET BUIS Ø 20



BLOC DE SÉCURITÉ 3H
ARMATUREUR POUR NOODVERLICHTING 3H

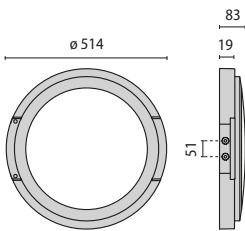

DIMENSIONS EMBALLAGE / AFMETINGEN VERPAKKING

12,5 x 53,5 x 53,5 cm (master x 1)

ENTRAXES DE FIXATION / ASMATEN VOOR INSTALLATIE

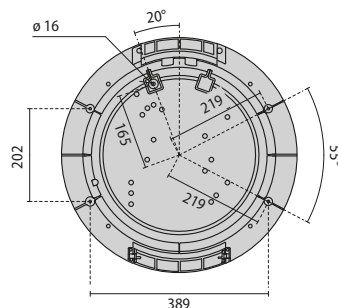

WH1
BLANC
WIT



GR3
GRIS MÉT.SATINÉ
GRIJS METALLIC MAT



AN3
ANTHRACITE MÉT. SATINÉ
ANTRACIET METALLIC MAT

De aanwezigheid van de gegevens betreffende de Kelvingraden, betekent dat de lamp is inbegrepen.
La présence de la donnée relative aux degrés Kelvin indique que la lampe est comprise.

bloc de sécurité 3 heure / noodverlichting 3h
 raccordement en cascade / verbinding in cascade